



CU-104  
August 5, 2020



# 65UV5 Simplicity Integrated Flame Scanner with Internal Flame Relay



---

## DESCRIPTION

The Fireye 65UV5 flame scanner is a microprocessor-based flame scanner utilizing an ultraviolet tube-type sensor and an electro-mechanical self-checking shutter mechanism. The Fireye 65UV5 flame scanner incorporates an internal flame relay with a fixed ON/OFF threshold thereby eliminating the need for an external flame amplifier.

The 65UV5 scanner is available with a one-second or four second flame failure response time (FFRT) depending on the model selected. The “E” versions are one second FFRT, the non-“E” versions are four seconds FFRT. The Fireye 65UV5-1004QD, -1004EQD flame scanner provides an analog 4 to 20 mA output referenced to flame signal strength.

The Fireye 65UV5 flame scanner is powered from a 24 Vdc power source provided externally and includes an integral 8 pin quick disconnect connector. A color-coded internal LED indicates flame status and alarm condition. This can be viewed through a viewing port on the rear cover.

The 65UV5 housing has a NEMA 4X / IP66 rating. The unit is suitable for use in Class 1, Div. 2 hazardous environment groups A, B, C & D or Ex II3 G/D Ex nA IIC T4A.

65UV5 CEX models are wired directly via a terminal rail located within the CEX housing. Suitable glands must be used to terminate the cable at the housing.

Note: The 65UV5-1000, -1000E scanners became obsolete in 2008, and were replaced by the enhanced capability of the 65UV5-1004 and -1004E scanners. The 65UV5-1004QD and -1004EQD models with electrical quick-disconnect have replaced the original models equipped with ten feet of captive cable.

---

## APPLICATION

Fireye 65UV5 self-checking scanners are used to detect ultraviolet emissions from fossil fuel flames such as natural gas, coke oven gas, propane, methane, butane, kerosene, light petroleum distillates and diesel fuels.

---

## PRINCIPLE OF OPERATION

The 65UV5 scanners use a UV-eye detector. This detector is a sealed, gas filled, UV-sensitive tube containing two electrodes connected to a source of DC voltage. When UV radiation of sufficient energy falls upon the electrodes, electrons are released and the inter-electrode gas becomes conductive, resulting in an electric current flow from one electrode to the other. The current flow starts and ends abruptly and is known as an “avalanche.”

A very intense source of UV radiation will produce several hundred avalanches or pulses per second. With less radiation there will be fewer pulses per second. Upon total disappearance of flame, the detector output ceases. Thus, the presence or absence of pulses is an indication of the presence or absence of flame; the frequency of the pulses is a measure of flame intensity. When the pulses reach a sufficient level, the internal flame relay is energized.

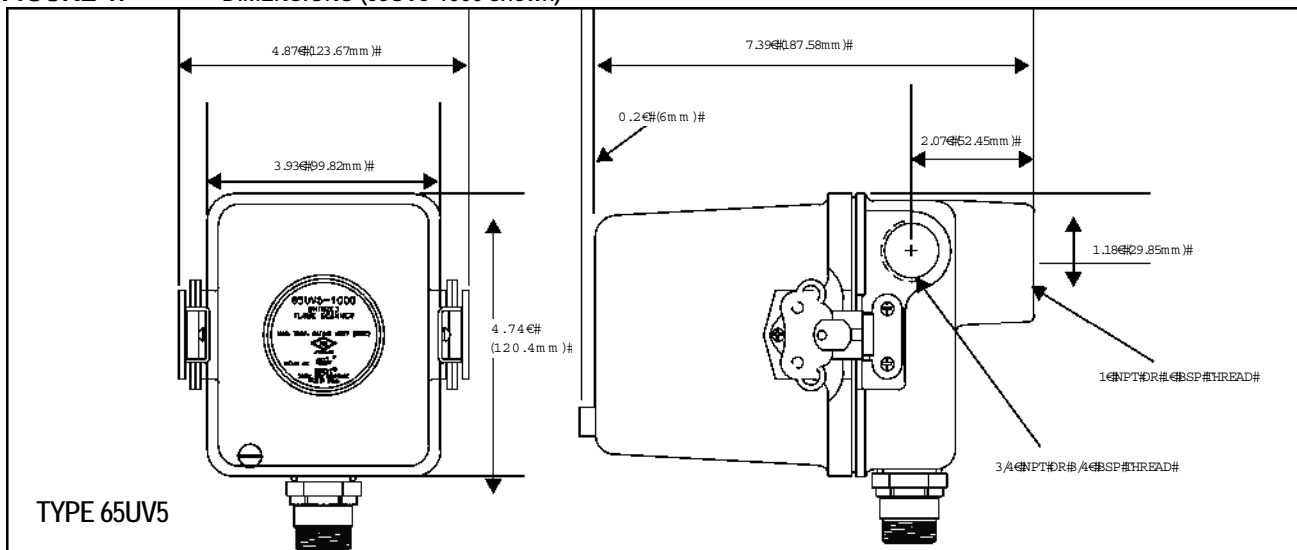


## FEATURES

The components are contained in a cast aluminum NEMA 4X/IP66 housing sealed with an oil-resistant gasket. The quartz lens is a planoconvex design, resulting in increased sensitivity. Also included in the scanner is an electromagnetic shutter that permits a self-checking circuit to verify that the scanner and signal circuits are producing valid flame presence or absence information. During the shutter closed period, the detector's optical path is blocked from flame radiation, allowing the internal microprocessor to verify the proper operation of the ultraviolet tube. While the shutter is open, flame presence or absence is detected. The self-check shutter operation and fault diagnostics are fully described later in this bulletin.

## SPECIFICATIONS

**FIGURE 1. DIMENSIONS (65UV5-1000 shown)**



## SPECIFICATIONS TABLE

**Table 1:**

SCANNER MODEL	MOUNTING THREADS		FLAME FAILURE RESPONSE TIME
	SIGHT PIPE CONNECTION, 1"	COOLING AIR CONNECTION, 3/4"	
65UV5-1004	NPT	NPT	4 Sec.
65UV5-1004E	BSP	BSP	1 Sec.
65UV5-1004QD	NPT	NPT	4 Sec.
65UV5-1004EQD	BSP	BSP	1 Sec.
65UV5-1004ECEX	BSP	BSP	1 Sec.



## SPECIFICATIONS (non CEX versions)

### MECHANICAL:

<b>Housing Material:</b>	Cast aluminum with black polyester powder coat finish
<b>Housing Weight:</b>	4 lbs (2kg)
<b>Environmental:</b>	NEMA 4X, IP66
<b>Hazardous Classifications:</b>	Class I, Division 2, Groups A, B, C & D, Class II, III, Division 2, Groups F and G Ex II 3 G/D Ex nA IIC T4A



**CAUTION:** Spring fasteners should be clipped and tightened to ensure a good bond to housing and maintain the integrity of the NEMA 4X rating.

<b>Mounting:</b>	Model 1000: 1" NPT female pipe mount with 3/4" NPT female cooling air connection Model 1000E: 1" BSP female pipe mount with 3/4" BSP female cooling air connection Model 1004 or 1004QD: 1" NPT female pipe mount with 3/4" NPT female cooling air connection Model 1004E or 1004EQD: 1" BSP female pipe mount with 3/4" BSP female cooling air connection
------------------	---

### Cooling / Purge Air Requirements:

<b>Source:</b>	Clean, dry, cool
<b>Volume:</b>	4 SCFM (113 l/min) at 3/4" threaded mounting flange, or 1 inch "Y" fitting, mounted on scanner sight pipe. Temperature near the upper limit of the scanner operating range and/or use with dirty/dusty fuels may require up to 15 SCFM (425 l/min).
<b>Pressure:</b>	Adequate to overcome furnace or windbox pressure
<b>Temperature Rating:</b>	-40° F to + 150°F (-40°C to +65°C)
<b>Humidity:</b>	0% to 95% relative humidity, non-condensing

### ELECTRICAL:

<b>Input Power:</b>	24 Vdc, + 20% / - 25%, 3.8 Watts
<b>Electrical Connection:</b>	8 pin quick disconnect connector
<b>Relay Output</b>	FLAME RELAY, (N.O.) / (N.C.) SPDT FAULT RELAY, (N.O.) SPST
<b>Contact Rating:</b>	Minimum: 1 mA @ 5 Vdc Maximum: 2 A @ 30 Vdc 2 A @ 240 Vac
<b>Status Indication:</b>	Internal LED: "Flame Signal", "Fault Indication"
<b>Analog Output:</b>	4-20 mA DC current, referenced to 24 Vdc common, maximum connected load 750 ohms

### CABLE SPECIFICATION:

<b>Cable Specification:</b>	P/N 59-598 (Quick Disconnect) Multi-core 8 conductor, color coded, #18 AWG wires and overall braided shield. PLTC-ER rating Eight #18 AWG
<b>Temperature Rating:</b>	-40 °F to 221 °F (-40°C to +105°C)
<b>Cable Jacket:</b>	PVC jacket Nominal O.D. = .44" (11.2 mm) Maximum O.D. = .48" (12.2 mm)



**Specification:** P/N 59-536 (used on cable gland version of 65UV5-1004, -1004E)  
 Multi-core 8 conductor, color coded, #18 AWG wires and overall braided shield.  
 Nominal O.D. = .38" (9.6 mm)  
 RoHS Compliant

**Cable Jacket:** PVC jacket, Meets UL PLTC Class 1, Div 2, no conduit required.  
 UV resistant, Oil resistant.

**Temperature Rating:** -40 °C to 105 °C

## SCANNER CABLES

**Table 2:**

PART NUMBER	DESCRIPTION	LENGTH	
		METERS	FEET
59-598-3	8-Conductor 3-meter cable assembly with 8-pin female connector.	3 meters	9 feet, 10 inches
59-598-6	8-Conductor 6-meter cable assembly with 8-pin female connector.	6 meters	19 feet, 8 inches
59-598-9	8-Conductor 9-meter cable assembly with 8-pin female connector.	9 meters	29 feet, 3 inches
59-598-12	8-Conductor 12-meter cable assembly with 8-pin female connector.	12 meters	39 feet, 4 inches
59-598-15	8-Conductor 15-meter cable assembly with 8-pin female connector.	15 meters	49 feet, 2 inches
59-598-30	8-Conductor 30-meter cable assembly with 8-pin female connector.	30 meters	98 feet, 5 inches
59-598-45	8-Conductor 45-meter cable assembly with 8-pin female connector.	45 meters	147 feet, 7 inches
59-598-60	8-Conductor 60-meter cable assembly with 8-pin female connector.	60 meters	196 feet, 10 inches
59-598-90	8-Conductor 90-meter cable assembly with 8-pin female connector.	90 meters	295 feet, 3 inches
59-598	8-Conductor cable <b>without connector</b> . Sold by the foot for use as extension cable from a junction box.	As required	As required

Agency Approvals:

65UV5-1004QD, 65UV5-1004EQD, 65UV5-1004QD, 65UV5-1004ECEX:

- UL C/US: MCCZ.MP1537, MCCZ7.MP1537
- FM: FM 7610, FM 3611
- American Bureau of Shipping (ABS): 10-HS548789D-PDA

65UV5-1004EQD, 65UV5-1004ECEX:

- CE: KIWA: 0063BT1067
- DIN DVGW: NG-2530BN0662
- DIN CERTCO: 5F209

65UV5-1004ECEX:

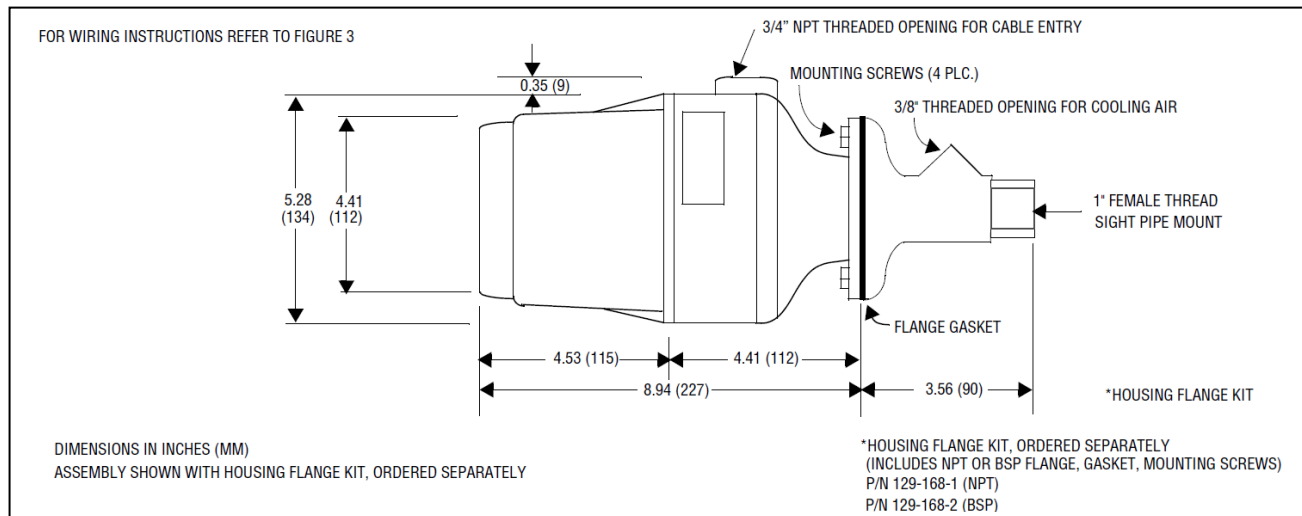
- Korea Occupational Safety & Health Agency (KOSHA)

Based on Fireye Marketing Memo #82404/JD dated May 1, 2017, Fireye certifies that the 65 Series Simplicity scanners are suitable for installations up to and including SIL2



## SPECIFICATIONS (CEX MODEL)

**FIGURE 2.** SIMPLICITY SCANNER in CENELEC HAZARDOUS AREA HOUSING (mounting flange kit ordered separately)



**NOTE:** All models of the Simplicity 65UV5-1004 CEX flame scanners are housed within an ATEX approved housing for application in Exd IIC T6 hazardous rated environment. In addition, the ATEX housing is designed to meet the requirements of IP66 (NEMA 4X).

## SPECIFICATIONS (CEX MODEL)

### MECHANICAL:

**Housing Weight:** 6.6 lbs (2.99kg)

**Hazardous Classifications:** Exd IIC T6 ATEX

### Cooling / Purge Air Requirements:

**Source:** Clean, dry, cool

**Volume:** 4 SCFM (113 l/min) at 3/4" threaded mounting flange, or 1 inch "Y" fitting, mounted on scanner sight pipe. Temperature near the upper limit of the scanner operating range and/or use with dirty/dusty fuels may require up to 15 SCFM (425 l/min).

**Pressure:** Adequate to overcome furnace or windbox pressure

**Temperature Rating:** -40° F to + 150°F (-40°C to +65°C) maximum dependent on "T" classification

**Humidity:** 0% to 95% relative humidity, non-condensing

### ELECTRICAL:

**Input Power:** 24 Vdc, + 20% / - 25% supply current 100 mA

**Electrical Connection:** Internal terminal rail

**Relay Output** FLAME RELAY, (N.O.) / (N.C.) SPDT

FAULT RELAY, (N.O.) SPST

**Contact Rating:** Minimum: 1 mA @ 5 Vdc

Maximum: 2 A @ 30 Vdc

2 A @ 240 Vac

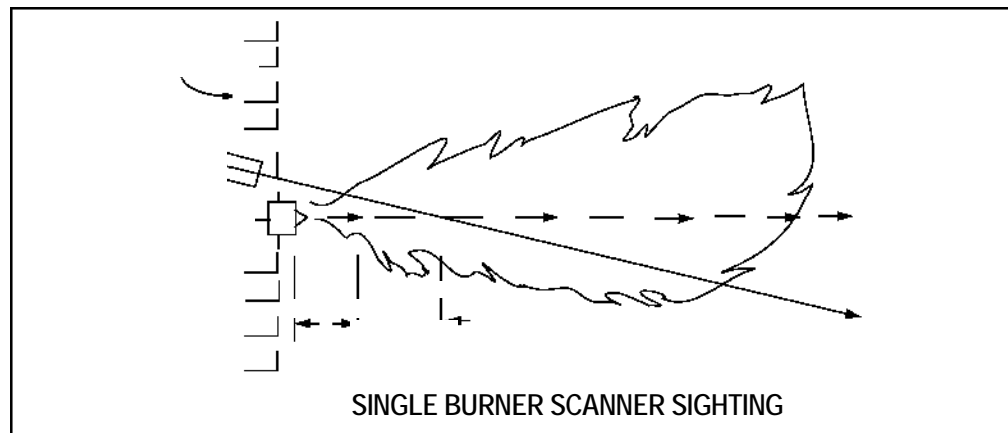
**Status Indication:** Internal LED: "Flame Signal", "Fault Indication"

**Analog Output:** 4-20 mA DC current, referenced to 24 Vdc common, maximum connected load 750 ohms

## INSTALLATION

The best scanner sighting results are obtained when the scanner is aimed so that its line of sight intersects the burner center line at a slight angle, as shown in Figure 3. The area of maximum ultraviolet radiation is near the base of the flame envelope. When only one scanner is used per burner, the intersection should be made so the line of sight or viewing angle can also see the pilot flame. Consideration must be given to burner secondary air rotation (some burners have clockwise air rotation and others counterclockwise). Figure 3 illustrates how scanner location is influenced by the pilot positions and secondary air circulation. Physical obstructions such as air register blades should not fall in the line of sight of the scanner.

FIGURE 3.

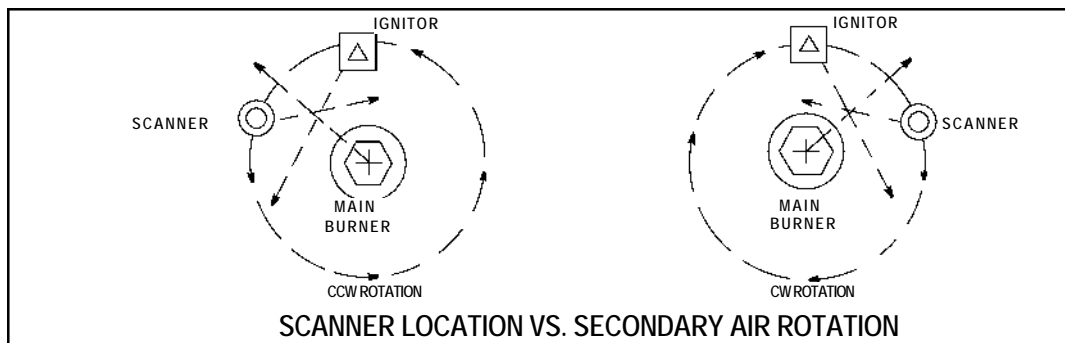


1. AN ACCEPTABLE SCANNER LOCATION MUST ENSURE THE FOLLOWING:

- Reliable pilot flame detection.
- Reliable main flame detection.
- Rejection of pilot flame too short or in the wrong position to ignite the main flame reliably, thus prohibiting main fuel admission.

*NOTE: Reliable signals must be obtained at all air flows and furnace loads (ranges of fuel firing).*

FIGURE 4.



2. If combustion air enters the furnace with a rotational movement of sufficient velocity to deflect pilot flame in direction of rotation, position the scanner 0 to 30 degrees downstream of the pilot burner and close to the periphery of the throat where the ultraviolet radiation is at a maximum. (See Figures 3 and 4).
3. Having determined an appropriate location for the sight tube, cut a clearance hole for a 2 inch pipe through the burner plate. If register vanes interfere with the desired line of sight, the interfering vane(s) should be trimmed to assure an unobstructed viewing path at all firing levels, see Figure 4.

4. Mount scanner sight pipe by either:
  - Centering a Fireye No. 60-1664-3 (NPT) or 60-1664-4 (BSP) swivel mount over the hole and installing the sight pipe on the swivel mount,
  - or**
  - Inserting the end of the sight pipe into the hole, aligning the pipe to the desired viewing angle and tack weld. (Welding must be adequate to temporarily support the weight of the installed scanner). The sight pipe should be arranged to slant downward so that the dirt and dust will not collect in it.

FIGURE 5.




5. When a satisfactory sighting position has been confirmed by operational test, (see section on alignment), the sight pipe should either be firmly welded in place or, if the swivel mount is used, the base position should be secured by tightening the three hex head cap screw located on the swivel mount ring. In certain older style swivel mounts, tack welding may be required.
6. Excessive flame signal can affect flame discrimination and prevent the control connected to the scanner from performing properly. To reduce the signal level of the tube, or improve flame discrimination, orifices may be installed to decrease the scanner's field of view and reduce its sensitivity. Installation of the orifice disk is shown in Figure 11.
7. The scanner viewing window must be kept free of contaminants (oil, smoke, soot, dirt) and the scanner temperature must not exceed its maximum rating. Both requirements will be satisfied by continuous injection of purge air.

The scanner mounting may be made with provision for purge air through the 3/4" opening as shown in Figure 6, Item A or C, or through a 1" tee/wye connection as shown in Figure 6, Item B. Normally only one of the two connections is provided with purge air and the other is plugged. When a Fireye coupling is used as shown in Figure 6, the 1" tee/wye connection is used for the purge air (plug 3/4" opening).

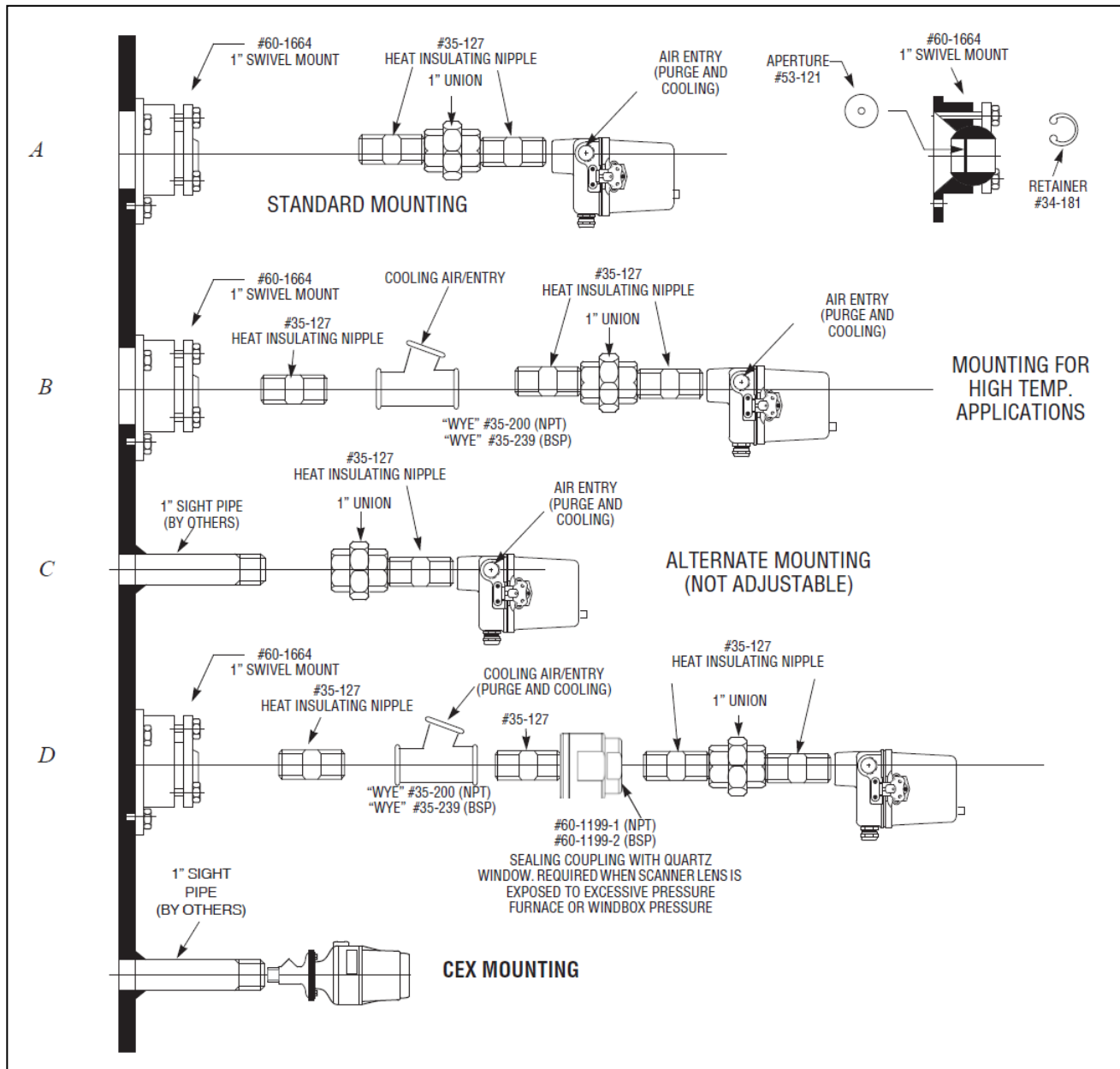
Under normal temperature conditions, with clean burning fuels and moderate ambient temperature conditions, purge air flow of approximately 4 SCFM (113 L/min) is generally adequate. A 0.1 psig positive pressure difference between the atmosphere and boiler pressure measured at right angle to the purge air flow, should result in a purge air flow of 4 SCFM. Up to 15 SCFM (425 L/min) may be required for fuels that may produce high levels of smoke or soot or for hot environments to maintain scanner internal temperature within specifications.

**NOTE:** The maximum viewing field of the lens is one inch per foot. Do not use more than one foot of one-inch sight pipe. Increase sight pipe diameter one inch for every additional foot of sight pipe length used, to avoid restricting the scanner's field of view. Temperature in the scanner housing should not exceed those temperature limits listed in the specifications. Excessive temperatures will shorten scanner life.



**WARNING: Sighting position of the flame scanner should ensure that the scanner does not respond to the ignition spark.**

FIGURE 6.



**SCANNER WIRING**

To reduce electrical noise interference, the scanner cable should be installed in flexible or rigid conduit. Take precautions to keep the scanner cable away from any high inductive wiring associated with high inductive loads or high voltage, or high energy spark ignition systems.

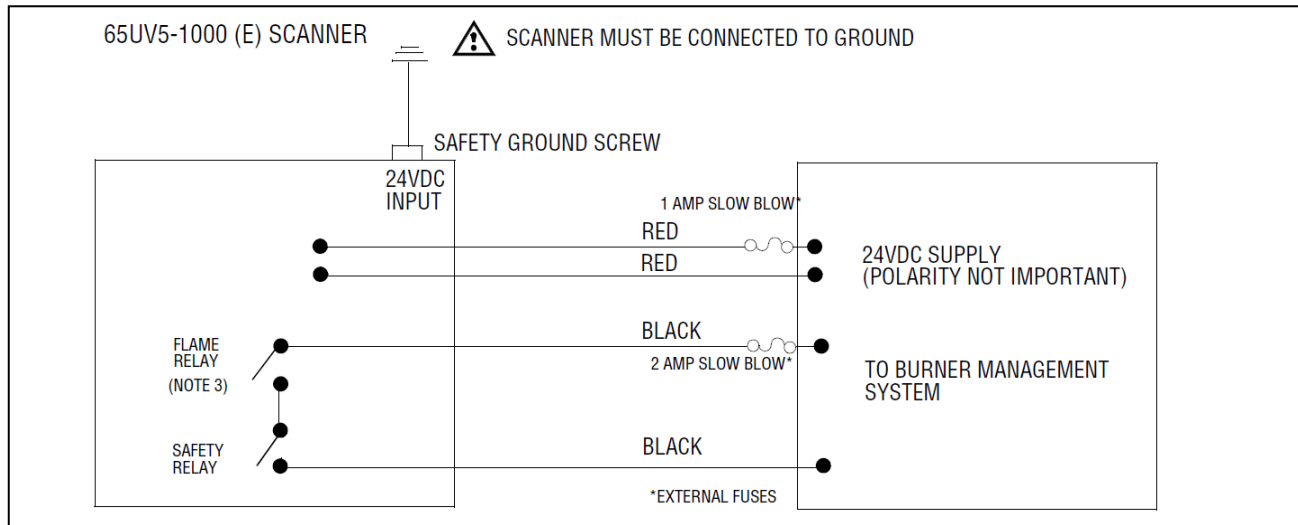


**WARNING:** Unit should be electrically protected by external fuses (see Fig. 7 and Fig. 8 for rating) to prevent damage to unit in case of a short or overload.

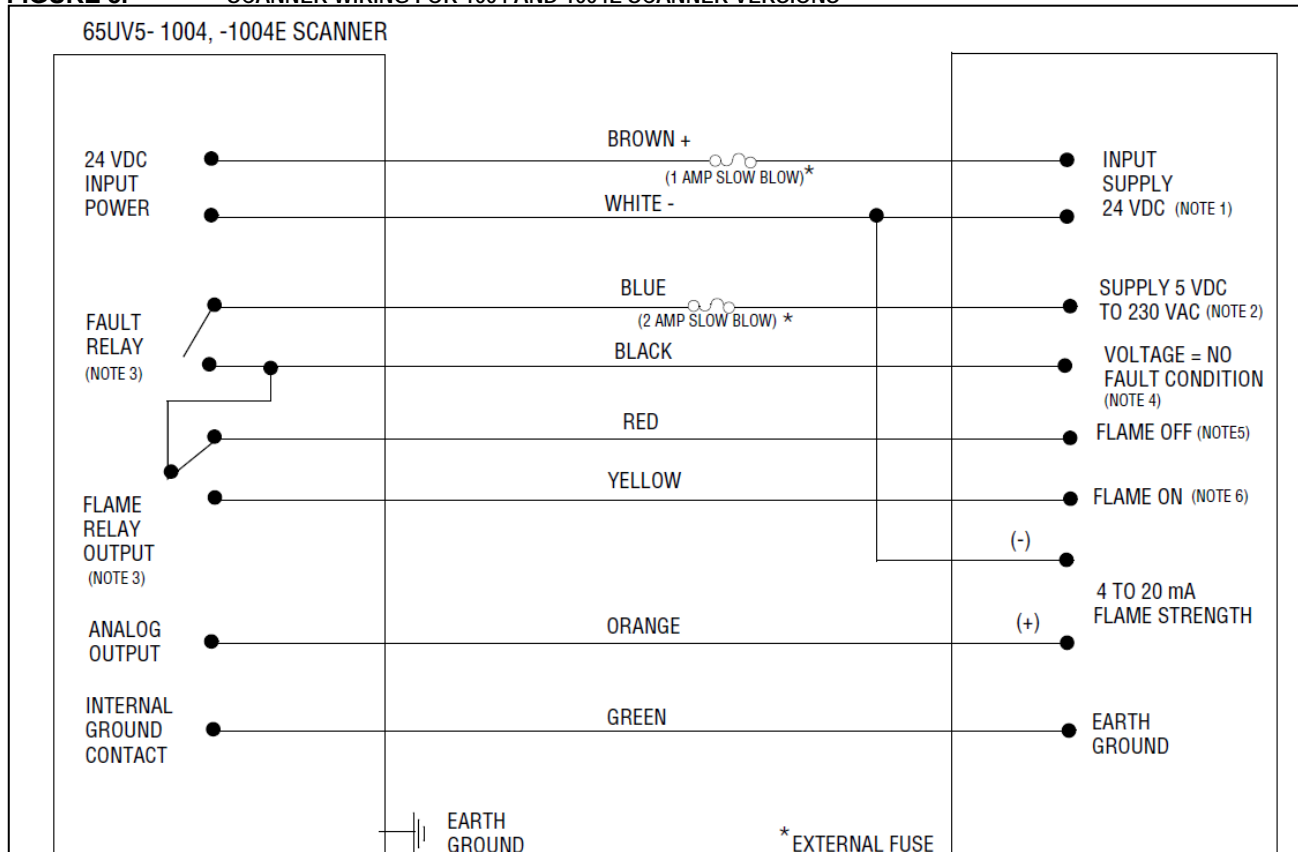




**FIGURE 7. SCANNER WIRING FOR 1000 AND 1000E SCANNER VERSIONS**



**FIGURE 8. SCANNER WIRING FOR 1004 AND 1004E SCANNER VERSIONS**



**CABLE COLOR CODES AND DESCRIPTIONS**

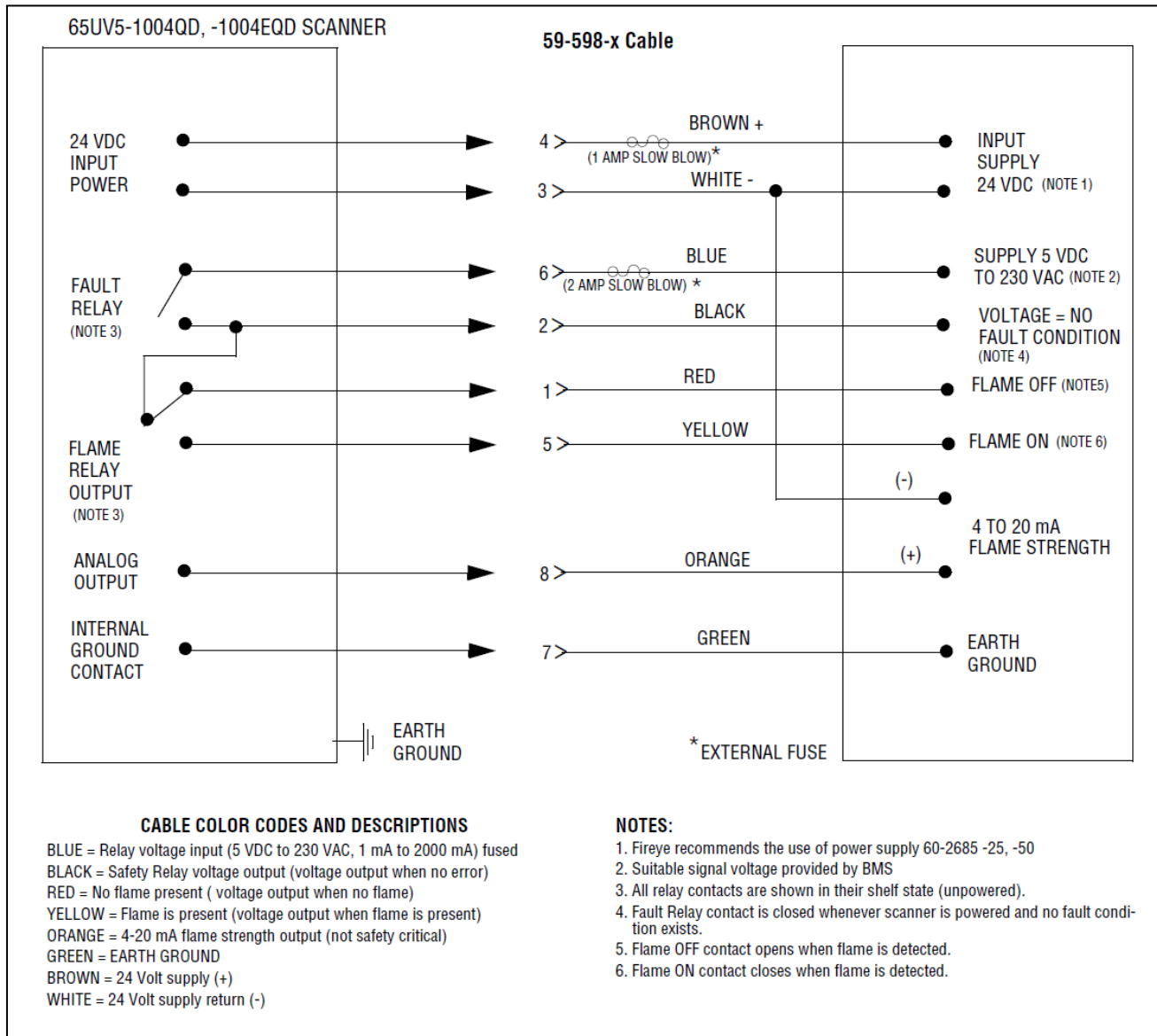
- BLUE = Relay voltage input (5 VDC to 230 VAC, 1 mA to 2000 mA) fused
- BLACK = Safety Relay voltage output (voltage output when no error)
- RED = No flame present (voltage output when no flame)
- YELLOW = Flame is present (voltage output when flame is present)
- ORANGE = 4-20 mA flame strength output (not safety critical)
- GREEN = EARTH GROUND
- BROWN = 24 Volt supply (+)
- WHITE = 24 Volt supply return (-)

**NOTES:**

1. Fireye recommends the use of power supply 60-2685 -25, -50
2. Suitable signal voltage provided by BMS
3. All relay contacts are shown in their shelf state (unpowered).
4. Fault Relay contact is closed whenever scanner is powered and no fault condition exists.
5. Flame OFF contact opens when flame is detected.
6. Flame ON contact closes when flame is detected.

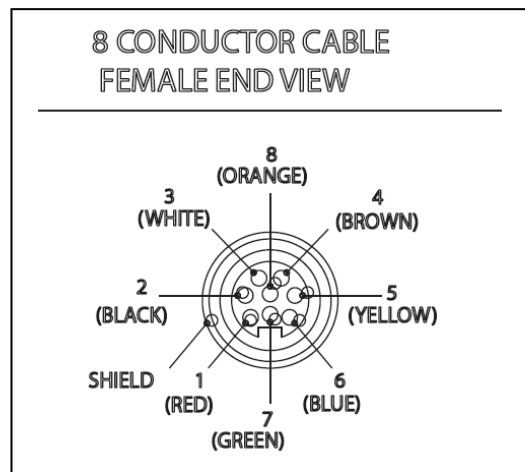


**FIGURE 9. SCANNER WIRING FOR 1004QD AND 1004EQD SCANNER VERSIONS**



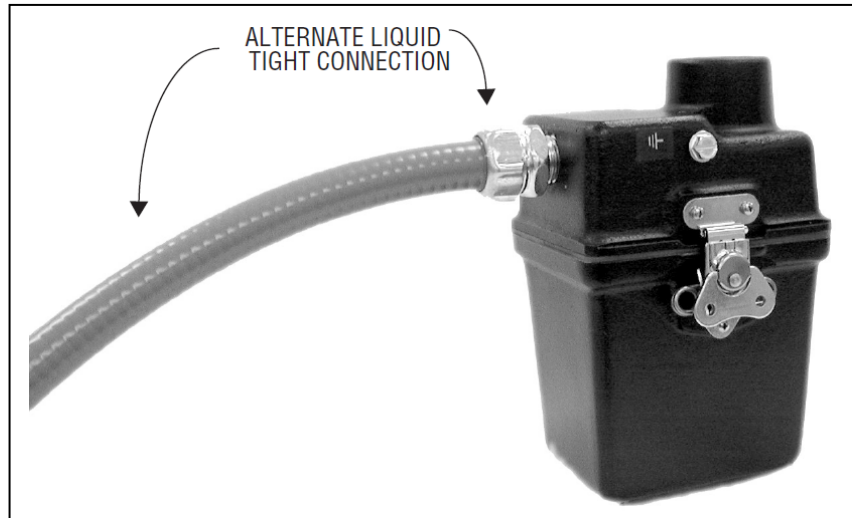
Wire colors and function of the 59-598-x quick disconnect cable are identical to the integral cable on the 65UV5-1004, -1004E

**FIGURE 10. 59-598-X CABLE CONNECTOR 8 PIN LOCATION**





*Note: When the older generations of 65UV5-1000 or -1000E scanners are used for a Class 1, Div. 2 application, the cable gland MUST be removed and replaced with P/N 129-149, liquid tight cable gland, so that liquid tight flexible conduit (Anaconda Sealtight ® 1/2" Type H.T.V.A or equivalent, available at any electrical supply outlet) can be inserted over the existing cable. The newer generation 65UV5-1004QD and 1004EQD utilize a special cable and connector that is approved for use in a Class 1, Div. 2 area without the use of the flexible conduit.*



## SCANNER WIRING - CEX VERSIONS

CEX models contain two internal four-pole terminal blocks for the user to connect their scanner cable. The terminal blocks are identified by the internal wire color code and functions as described in Table 2 and Figure 9 below.

The installer must use a suitable EX cable gland or conduit fitting at the CEX housing's  $\frac{3}{4}$ " NPT threaded cable entry opening.

To reduce electrical noise interference, take precautions to keep the scanner cable away from any high inductive wiring associated with high inductive loads or high voltage, high energy spark ignition systems.



**WARNING: Unit should be electrically protected by external fuses (see Fig. 7 and Fig. 8 for rating) to prevent damage to unit in case of a short or overload.**

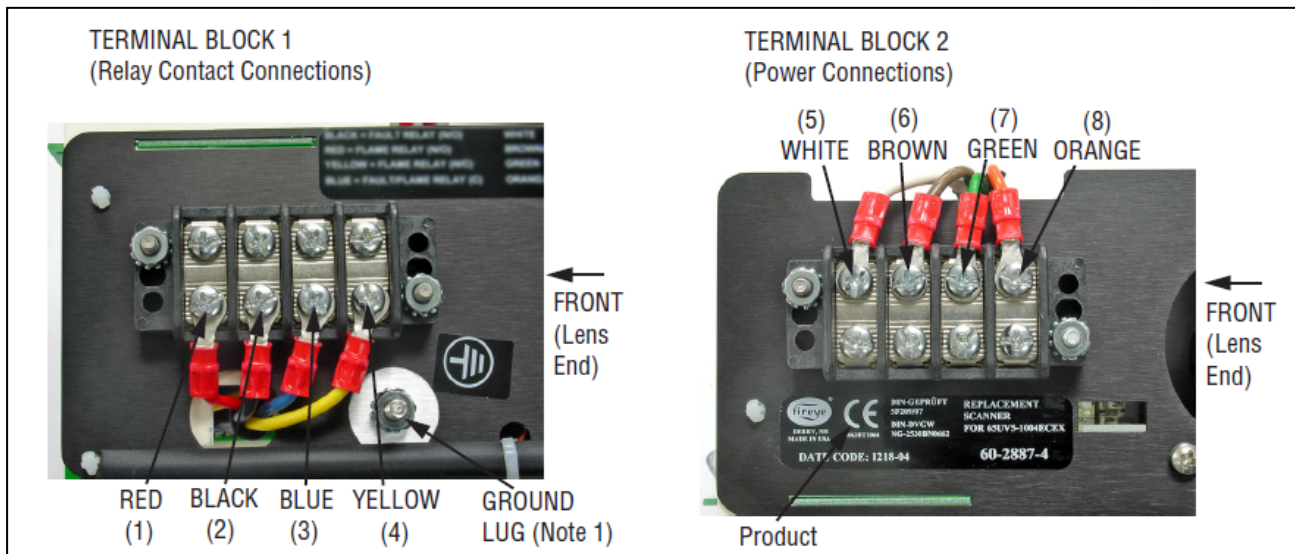
**Table 3: WIRING OF SIMPLICITY MODEL 65UV5-1004 "CEX" SCANNERS**

TERMINAL		INTERNAL WIRE COLOR CODE	FUNCTION
TERMINAL BLOCK 1 (RELAY CONTACT CONNECTIONS)	1	RED	FLAME RELAY (N.C.)
	2	BLACK	FAULT/ FLAME RELAY (COM)
	3	BLUE	FAULT RELAY (N.O.)
	4	YELLOW	FLAME RELAY (N.O.)
TERMINAL BLOCK 2 (POWER CONNECTIONS)	5	WHITE	24 VDC (-) SUPPLY
	6	BROWN	24 VDC (+) SUPPLY
	7	GREEN	EARTH GROUND
	8	ORANGE	4-20 mA OUTPUT (+)

*Note: 4-20mA negative connection should connect to the power supply negative wire (white).*



**FIGURE 11.** 65UV5-1004 “CEX” INTERNAL WIRING - COLOR CODE



### SELF-CHECK SHUTTER OPERATION

The 65UV5 self-check shutter mechanism is a powered-open, powered-closed device (no return spring). The open/closed shutter period is variable and controlled by the scanner’s microprocessor.

Upon initial 24 vdc power application, the shutter will close and open once to verify proper operation. The shutter will then remain open until a UV flame source is present and the internal flame relay (RF) is energized.

When the flame relay (RF) is energized, the shutter will be driven closed once every 12 seconds. The amount of time the shutter will remain closed is determined by the scanner’s microprocessor and is dependent upon the UV tube’s response. The amount of time closed can vary between 50 ms and 300 ms.

In the event of a self-check failure the flame relay will de-energize.

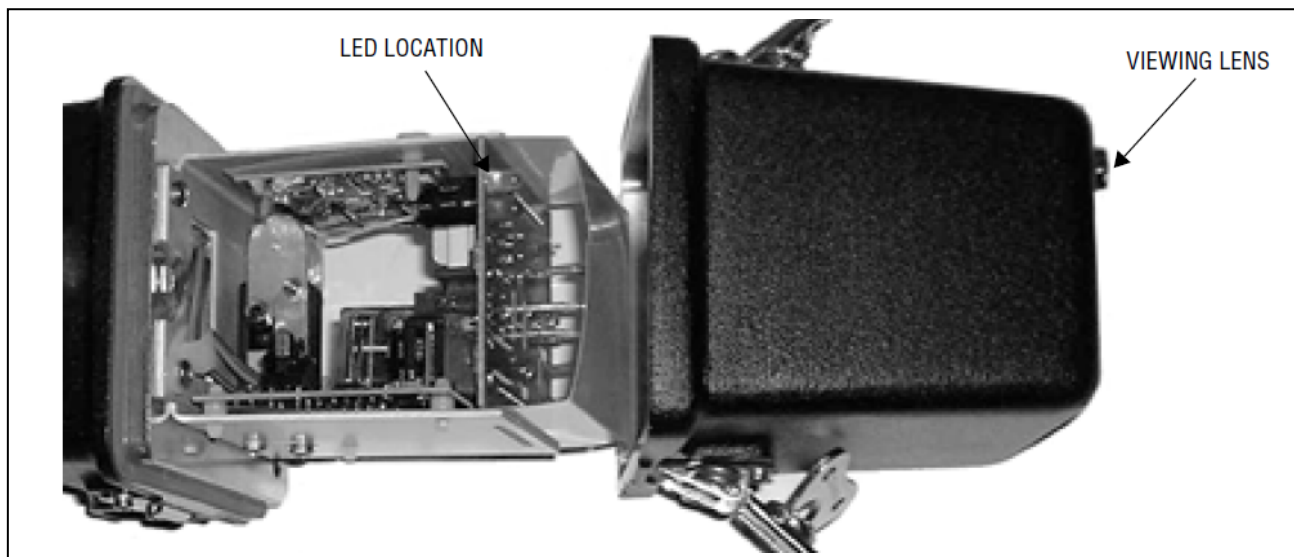
### INDICATION LEDs

The 65UV5 contains a color-coded internal LED that indicates flame status and alarm condition per the following table. View LED through lens on back of housing. Refer to Fig. 12 for LED location.

**Table 4:**

LED STATUS		CONDITION	FLAME RELAY (RF) STATUS	*SHUTTER	
				OPEN	CLOSED
GREEN	OFF	NO FLAME DETECTED	OFF		
	ONCE PER SECOND FLASHING RATE	MARGINAL FLAME SIGNAL	ON		
	RAPID FLASHING RATE	NORMAL FLAME SIGNAL	ON		
	STEADY ON	HIGH FLAME SIGNAL	ON		
RED	OFF	NORMAL	ON		
	FLASHING	*SELF-CHECK FAILURE (observe shutter position)	OFF	SHUTTER FAILURE	UV TUBE FAILURE
	ON	MICROPROCESSOR ERROR	OFF		

FIGURE 12.



## ALIGNMENT AND ADJUSTMENT

The following procedures are recommended to ensure optimum flame detection and discrimination. Flame discrimination is the ability to see only one burner or one pilot with other burners or pilots operating nearby. These procedures should be used whenever parts are replaced, when the scanner has been moved, when the flame shape is altered (additional fuels, new burners, burner/register modifications) as well as on all new installations.



**CAUTION: Ensure scanner does not respond to the ignition spark.**

### Pilot Flame Scanner

1. Apply power to scanner.
2. Start pilot.
3. Adjust scanner sighting to detect pilot flame in the manner shown in Figure 4.
4. When flame is properly sighted, the flame signal relay should energize, and the internal LED should be indicating Flame Signal (see table 3).
5. Make sure that the scanner does not respond to the ignition spark. This is accomplished by cutting off the fuel to the pilot and attempting to start the pilot using the spark igniter. If the system responds to the spark, the sighting should be realigned.



**CAUTION: Minimum pilot is the minimum flame required to satisfactorily ignite the main burner. Be sure to test for reliable signals under maximum airflow conditions when the pilot may not be detected outside the line of sight. If this occurs, resighting is required.**

### Main Flame Scanner

1. Apply power to scanner.
2. Start pilot.
3. Adjust scanner sighting so that ignition spark and pilot flame are not detected. Test should be conducted with maximum pilot flame and with both minimum and maximum airflow.
4. Start main burner.



5. Adjust scanner sighting to detect main burner flame. When sighting is correct (see above), the flame relay should energize, and the internal LED should be indicating Flame Signal (see table 3).
6. When proper signal is established, manually close off the main burner fuel supply. When burner flame becomes unstable or is extinguished, the flame relay should de-energize and the internal LED should be off.
7. Start an adjacent burner and vary its firing rate under normal airflow conditions. Make certain that the main flame scanner on the burner not in service does not respond to adjacent burner flame. Readjust sighting if necessary.

**ACCESSORIES**

**Swivel Mount**

The scanner swivel mount P/N 60-1664-4 (BSP) or 60-1664-3 (NPT) is used to adjust the scanner sighting angle after the scanner has been installed. The swivel mount is used as indicated the figures in this document.

**Orifices**

The Orifice restricts the field of view (target area), reduces air flow, maintains air flow, maintain air block, and increases discrimination between flame and background radiation. The orifice is secured within the ball of a swivel mount with an orifice retainer or the orifice can be placed within a one-inch union (not provided).

The scanner should ideally sight a target area of 4 to 25 square inches (25-150 cm<sup>2</sup>) of the flame front. The flame front is a plane within the combustion space separating the region of unburned fuel from the burning fuel.

*Note: There is an inverse relationship between discrimination and sensitivity.*

**Table 5:**

FIGURE	PART NUMBER	DESCRIPTION
14	53-121	Orifice Kit Contains the Following:
14A	53-121-2	Orifice .062" Diameter
14B	53-121-3	Orifice .078" Diameter
14C	53-121-4	Orifice .093" Diameter
14D	53-121-5	Orifice .109" Diameter
14E	53-121-6	Orifice .125" Diameter
14F	53-121-7	Orifice .187" Diameter
14G	53-121-8	Orifice .250" Diameter
14H	53-121-9	Orifice .375" Diameter
14I	53-121-10	Orifice .50" Diameter
14J	34-181	Orifice Retainer

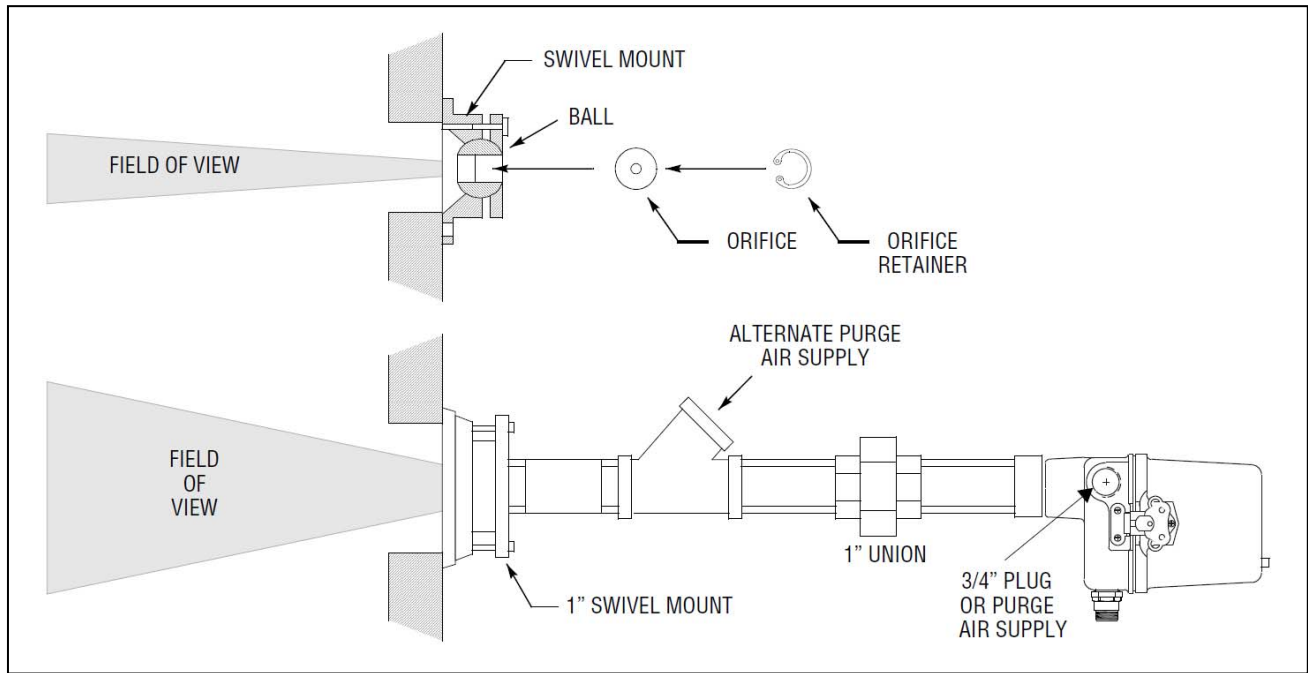
**Heat Insulating Nipple**

The heat insulating nipple P/N 35-127-3 (BSP) or 35-127-1 (NPT) prevents heat transfer from the hot sight pipe to the scanner head.

**Sealing Coupling with Quartz Window**

The sealing coupling (60-1199-x) is used whenever a coupling or seal is required for scanner piping. The size is one-inch US standard taper pipe thread (1" NPT). The sealing coupling has a quartz window to block off the scanner from the furnace pressure and heat. When the sealing coupling is used, the 1" tee/wye is used for the purge air inlet. Be sure the quartz window is properly seated to seal off the scanner. Do not over-tighten coupling collar because damage to the window may result. For best results, hand tighten coupling collar.

FIGURE 13.



**MAINTENANCE**

1. The control and scanner should be powered at all times (except for repair, cleaning or replacement) to reduce any harmful effects of atmospheric humidity.
2. The scanner and sight pipe must be kept clean to prevent overheating and assure optical qualities.
3. When replacing or cleaning the UV tube, note the position of the tube pins. They are mounted on a rectangular base so that the tube can only be inserted into the socket with the electrodes broadside to the shutter window.



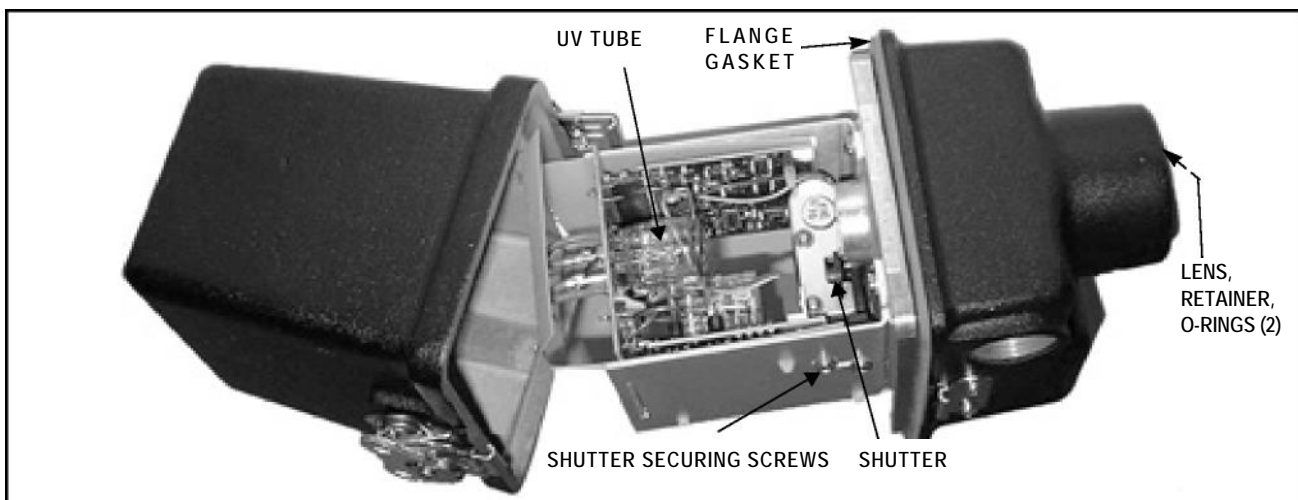
**CAUTION: DISCONNECT OR SHUT OFF ELECTRIC POWER WHEN WORKING ON SCANNER.**

4. Clean the quartz lens and tube with glass detergent or glass cleaning agents which contain no abrasives. After cleaning, remove all cleaning films with a soft lint-free cloth. (Some cleaning films may reduce or filter UV).
5. Use original FIREYE parts to maintain optimum operation, see table 5.

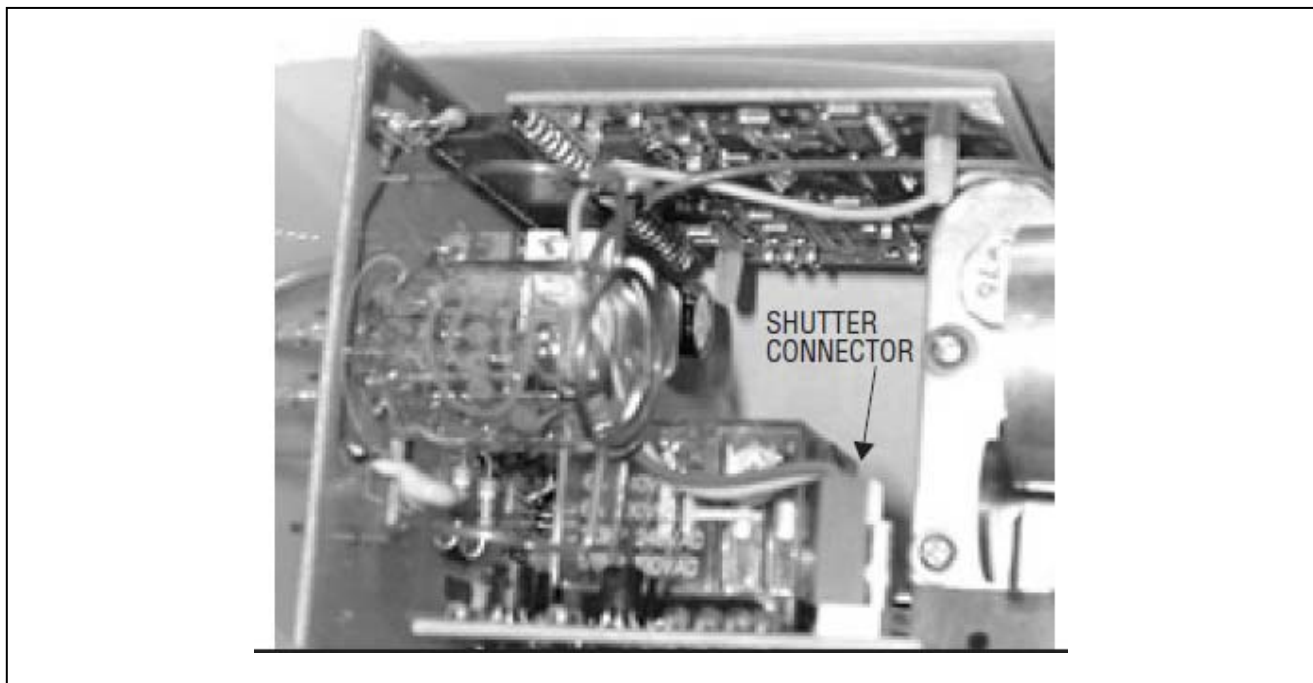
**Table 6:**

RECOMMENDED SPARE PARTS	
Part Number	Description
4-290-1	UV Tube
002608-001	Flange Gasket
002611-001	Scanner Lens
101537-001	Lens Retaining Ring
107427-006	Lens O-Ring (2 required)

**FIGURE 14.**



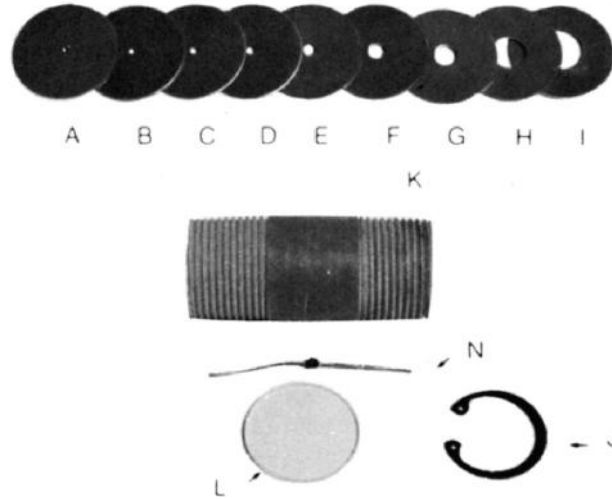
**FIGURE 15.**





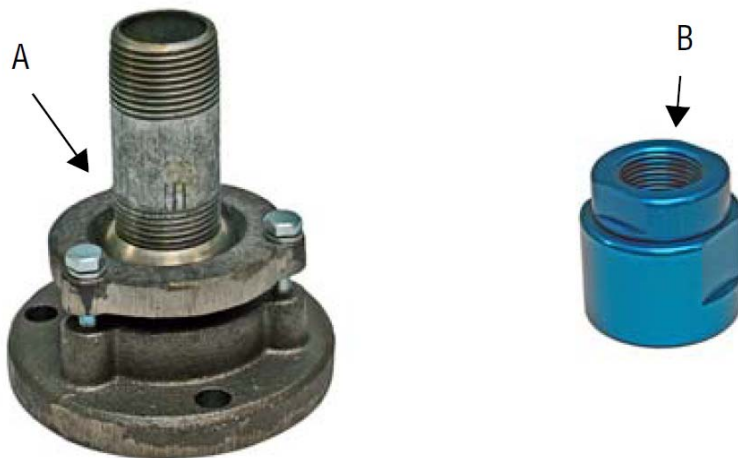
**FIGURE 16.**

- A. THROUGH I. ORIFICES .062 DIA TO .5 DIA
- J. 34-181 ORIFICE RETAINER
- K. 35-127-1 (NPT) HEAT INSULATING NIPPLE 35-127-3 (BSP) HEAT INSULATING NIPPLE#
- L. 92-48 QUARTZ WINDOW (for 61-1199 Sealing Coupling shown in Fig. 15).



**FIGURE 17.**

- A. 60-1664-3 (NPT) SWIVEL MOUNT  
60-1664-4 (BSP) SWIVEL MOUNT
- B. 60-1199-1 (NPT) SEALING COUPLING W/QUARTZ WINDOW  
60-1199-2 (BSP) SEALING COUPLING W/QUARTZ WINDOW





---

## NOTICE

When Fireeye products are combined with equipment manufactured by others and/or integrated into systems designed or manufactured by others, the Fireeye warranty, as stated in its General Terms and Conditions of Sale, pertains only to the Fireeye products and not to any other equipment or to the combined system or its overall performance.

---

## WARRANTIES

FIREYE guarantees for *one year from the date of installation or 18 months from date of manufacture* of its products to replace, or, at its option, to repair any product or part thereof (except lamps, electronic tubes and photocells) which is found defective in material or workmanship or which otherwise fails to conform to the description of the product on the face of its sales order. **THE FOREGOING IS IN LIEU OF ALL OTHER WARRANTIES AND FIREYE MAKES NO WARRANTY OF MERCHANTABILITY OR ANY OTHER WARRANTY, EXPRESS OR IMPLIED.** Except as specifically stated in these general terms and conditions of sale, remedies with respect to any product or part number manufactured or sold by Fireeye shall be limited exclusively to the right to replacement or repair as above provided. In no event shall Fireeye be liable for consequential or special damages of any nature that may arise in connection with such product or part.