



**AIR PReSSURe SeNSING SWIt CH WIt H ADj USt ABLe Set P OINt R ANGe**

**APPLICAt ION**

**Model AFS-275 Air Pressure Sensing Switch** is a general purpose proving switch designed for HVAC and Energy Management applications. It can be used to sense positive, negative, or differential air pressure.

**GeNeRAL DeSCRIPt ION & OPeRAt ION**

The plated housing contains a diaphragm, a calibration spring and a snap-acting SPDT switch. The sample connections located on each side of the diaphragm accept flexible tubing.

**MOUNt ING (See F IGURe 1)**

Select a mounting location which is free from vibration. The **AFS-275** must be mounted with the diaphragm in any vertical plane in order to obtain the lowest specified operating set point. Avoid mounting with the sample line connections in the "up" position. Surface mount via the two 3/16" diameter holes in the integral mounting bracket. The mounting holes are 3-7/8" apart.

The **AFS-275** is equipped with two slip-on sample line connections, situated on either side of the diaphragm as shown in Fig. 2. These connections are suitable for flexible tubing. For sample lines of up to 10 feet, 1/4" OD tubing is acceptable. For lines up to 20

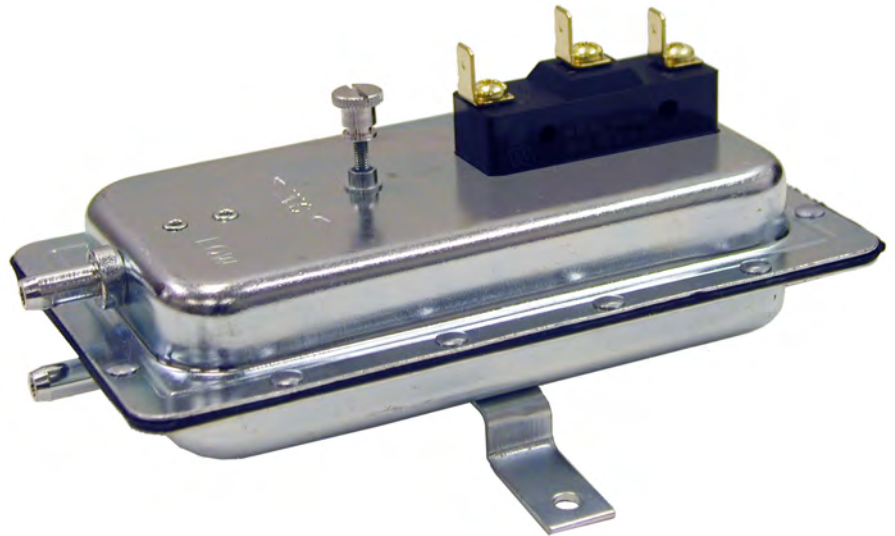
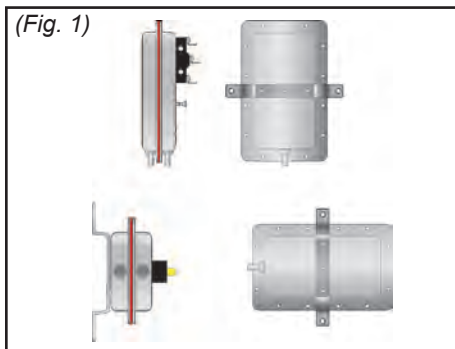

**AIR SAMPLING CONNeCt ION (See F IGURe 2)**

feet, use 1/4" ID tubing. For lines up to 60 feet, use 1/2" ID tubing. A 1/4" OD adapter, suitable for slip-on flexible tubing is available: order part number 18311.

Locate the sampling probe a minimum of 1.5 duct diameters downstream from the air source. Install the sampling probe as close to the center of the airstream as possible. Refer to Figure 2 to identify the high pressure inlet (H) and the low pressure inlet (L). Select one of the five application options listed below, and connect the sample lines as recommended.

**POSit IVe PReSSURe ONLY:** Connect the sample line to inlet H; inlet L remains open to the atmosphere.

**NeGAt IVe PReSSURe ONLY:** Connect the sample line to inlet L; inlet H remains open to the atmosphere.

**t WO NeGAt IVe SAMPLeS:** Connect the higher negative sample to inlet L. Connect the lower negative sample to inlet H.

**t WO POSit IVe SAMPLeS:** Connect the higher positive sample to inlet H. Connect the lower positive sample to inlet L.

**ONe POSit IVe AND ONe NeGAt IVe SAMPLe:** Connect the positive sample to inlet H. Connect the negative sample to inlet L.

(Figure 2)

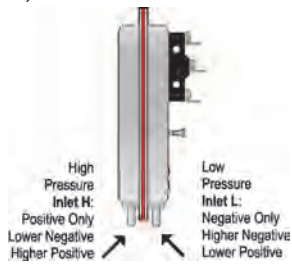

(Figure 3)

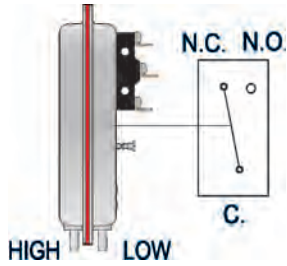

(Figure 4)

To prove excessive air flow or pressure:

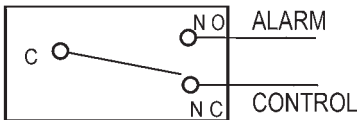

To prove insufficient air flow or pressure:

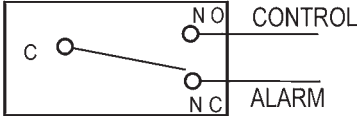

### eLeCt RICAL CONNeCt IONS (See FIGURE 3)

The snap switch has 1/4", 90° quick-connect spade terminals. Before pressure is applied to the diaphragm, the switch contacts will be in the normally closed (NC) position. Wire alarm and control applications as shown in Figure 4.

### FLeLD ADj USt MeNt

The adjustment range of an **AFS-275** Air Switch is 0.05±0.02" w.c. to 2.0" w.c. To adjust the set point, turn the adjusting screw counterclockwise until motion has stopped. Next, turn the adjusting screw 4 complete turns in a clockwise direction to engage the spring. From this point, the next ten turns will be used for the actual calibration. **each full turn represents approximately 0.2" w.c.**

**Please note:** To properly calibrate an air switch, a digital manometer or other measuring device should be used to confirm the actual set point.

### SPeCIFICAt IONS

### MODeL AFS-275 AIR PReSSURe SeNSING SWItCH WItH ADJ USt ABLe Set POINT RANGE

#### Mounting Position:

Mount with the diaphragm in any vertical plane.

#### Set Point Range:

0.05 ± 0.02" w.c. to 2.0" w.c.

#### Field Adjustable "Operate Range":

0.07" w.c. to 2.0" w.c.

#### Field Adjustable "Release Range":

0.04" w.c. to 1.9" w.c.

#### Approximate Switching Differential:

Progressive, increasing from 0.02 ± 0.01" w.c. at minimum set point to approximately 0.1" w.c. at maximum set point.

#### Measured Media:

Air, or combustion by-products that will not degrade silicone.

#### Maximum Pressure:

1/2 psi (0.03 bar).

#### Operating Temperature Range:

-40F to 180F (-40 to 82C).

#### Life:

100,000 cycles minimum at 1/2 psi maximum pressure each cycle and at maximum rated electrical load.

#### Electrical Rating:

300 VA pilot duty at 115 to 277 VAC, 15 amps noninductive to 277 VAC, 60Hz.

#### Contact Arrangement: SPDT.

#### Electrical Connections:

1/4", 90° quick-connect spade terminals.

#### Sample Line Connectors:

1/4" slip-on.

#### Sample Line Connections:

Connectors are suitable for flexible tubing.

#### Approvals: UL, FM, CSA, CE.

#### Shipping Weight: 1.2 lbs.

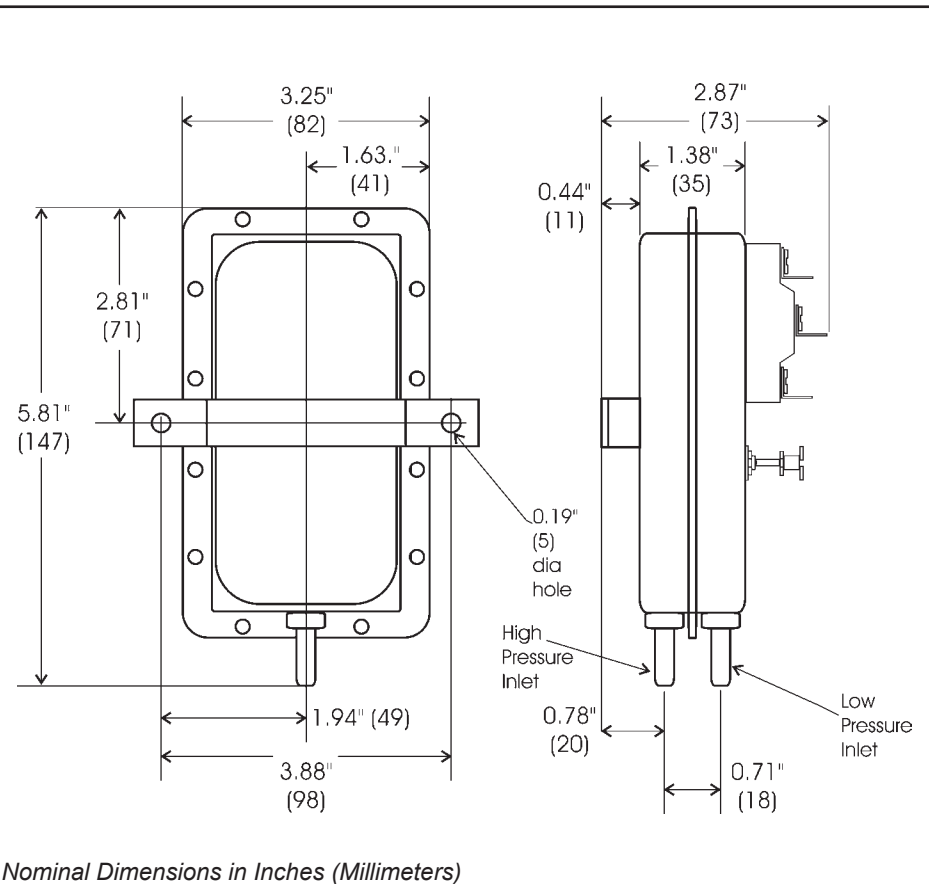

Nominal Dimensions in Inches (Millimeters)