

Instruction **Manual**

Liquitron™ DC4000 Series Conductivity Controller

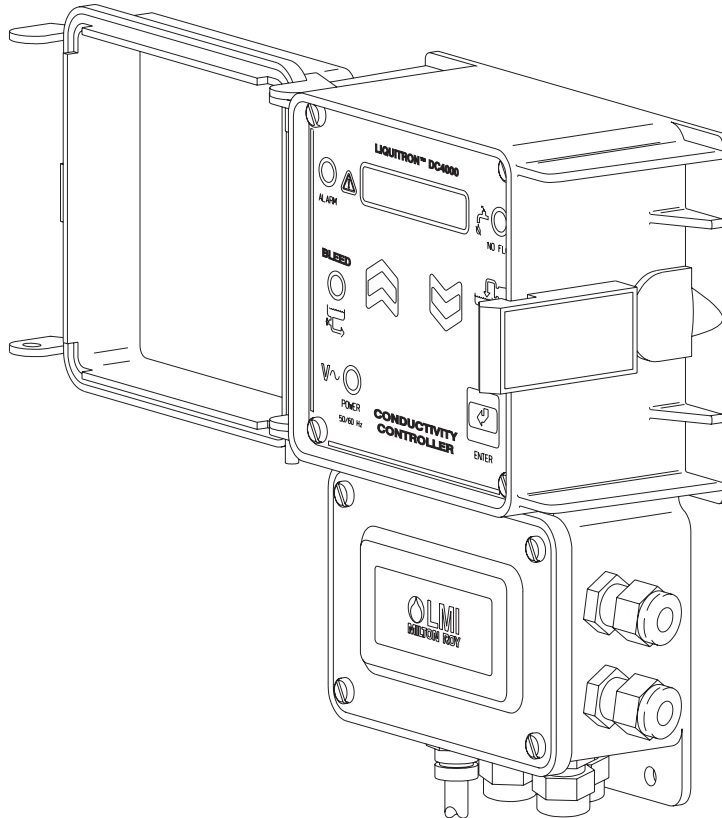

For file reference, please record the following data:

Model No: _____

Serial No: _____

Installation Date: _____

Installation Location: _____

When ordering replacement parts for your LMI Controller or accessory, please include the complete Model Number and Serial Number of your unit.



novatech
INTERNATIONAL

sales@novatech-usa.com

www.novatech-usa.com

Tel: (866) 433-6682

Tel: (281) 359-8538

Fax: (866) 433-6684

Fax: (281) 359-0084

201 Ivyland Road
Ivyland, PA 18974 USA
TOLL FREE: (800) 564-1097
TEL: (215) 293-0401
FAX: (215) 293-0445
<http://www.lmipumps.com>

Replaces same of Rev. E 11/99
1732. F 3/2013

Contents

1.0	Introduction.....	5
2.0	Installation.....	7
2.1	Mounting the Controller Enclosure.....	7
2.2	Enclosure Mounting Dimensions.....	8
2.3	Electrical Wiring Information.....	8
2.4	Terminal Strip Layout.....	9
3.0	Operating the Controller.....	16
3.1	Menu Overview.....	17
3.2	Conductivity.....	18
3.3	Set Point.....	19
3.4	Δ Differential.....	20
3.5	Low Alarm.....	21
3.6	High Alarm.....	22
3.7	Feed.....	23
3.8	Manual Outputs.....	24
3.9	Advanced Setup.....	25
3.10	Temperature.....	26
3.11	H ₂ O Meter.....	27
3.12	Boiler.....	28
4.0	Start-Up.....	30
4.1	Cooling Tower Installation.....	31
4.2	Pre-Start-Up Work Sheet.....	32
4.3	Boiler Installation.....	32
4.4	Determining the Blowdown Requirement.....	32
4.5	Timed Sampling Mode.....	33
4.6	Continuous Sampling.....	33
4.7	Boiler Installation Notes.....	33
4.8	Boiler Start-Up.....	34
4.9	Timed Sample Start-Up.....	34
4.10	Continuous Sample Start-Up.....	36
4.11	Closed Loop Installation Theory of Operation.....	36
4.12	Closed Loop Start-Up.....	36
4.13	Closed Loop Installation Notes.....	37
5.0	Functional Instructions.....	37
5.1	Calibration.....	37
6.0	Maintenance.....	39
6.1	Controller.....	39
6.2	Probe.....	30
7.0	Troubleshooting.....	40
8.0	Factory Settings.....	41
9.0	Product Specifications.....	41
10.0	Product Exploded View.....	42
11.0	Product Parts List.....	43
12.0	Warranty.....	44

1.0 Introduction

The DC4000 is a microprocessor-based conductivity controller. It is designed for use in a variety of water treatment applications requiring precise control of total dissolved solids and chemical feed. Among its many uses, the DC4000 will control conductivity and chemical feed in cooling towers, closed loop systems, and boilers.

LMI's DC4000 Series of conductivity controllers allows the greatest programming flexibility for cooling tower or boiler system applications. This is accomplished through the use of an options menu that is easy to use.

BLEED or BLOWDOWN of system water by valve control can be based on several setpoint options:

- Conductivity setpoint
- Hysteresis delay (lower than setpoint) to avoid valve operation chattering
- Rising or Falling conductivity trip points

FEED of chemical (inhibitor) can be based on four (4) different methods:

- FEED at the same time system BLEEDS (lockout timer limits maximum FEED time)
- FEED time calculated as a percentage of total BLEED time
- FEED based on a timed cycle (pump is on for a percentage of this timed cycle)
- FEED based on flow meter input

ALARM indicators and relay outputs are energized based on the following conditions:

- HIGH conductivity set point is reached
- LOW conductivity set point is reached
- NO FLOW condition exists (flow switch must be installed)

The display is a 16-character backlit LCD (liquid crystal display) which is visible in all light conditions. A three-key position membrane is used to enter data and settings (see Figure 1). The conductivity range is 0 - 20,000 μ Siemens. The units can be either μ Siemens or PPM/TDS (total dissolved solids). If the units displayed are PPM/TDS, the ratio of μ S: to: TDS can be selectively programmed.

All setpoints and parameter settings are retained permanently in a special nonvolatile computer chip memory, preventing their loss due to a power outage. This nonvolatile memory chip allows the unit to be programmed before installation. No battery powered backup is required.

Built in test circuits are provided to test each individual relay output wiring and to allow for quick field service isolation of faulty probe, circuit cards, pumps, or solenoid valves for ease of troubleshooting.

A display for temperature is also provided. The range is 32° F to 212° F [0° C to 100° C]. The display can be either fahrenheit or centigrade. This reading also provides the basis for temperature compensation which is performed in all modes except the boiler mode.

A 4-20 mA analog data (or control) output is provided. The conductivity reading that corresponds to minimum and maximum analog signals is fully programmable. This signal can be used to power chart recorders or other pumps and devices.

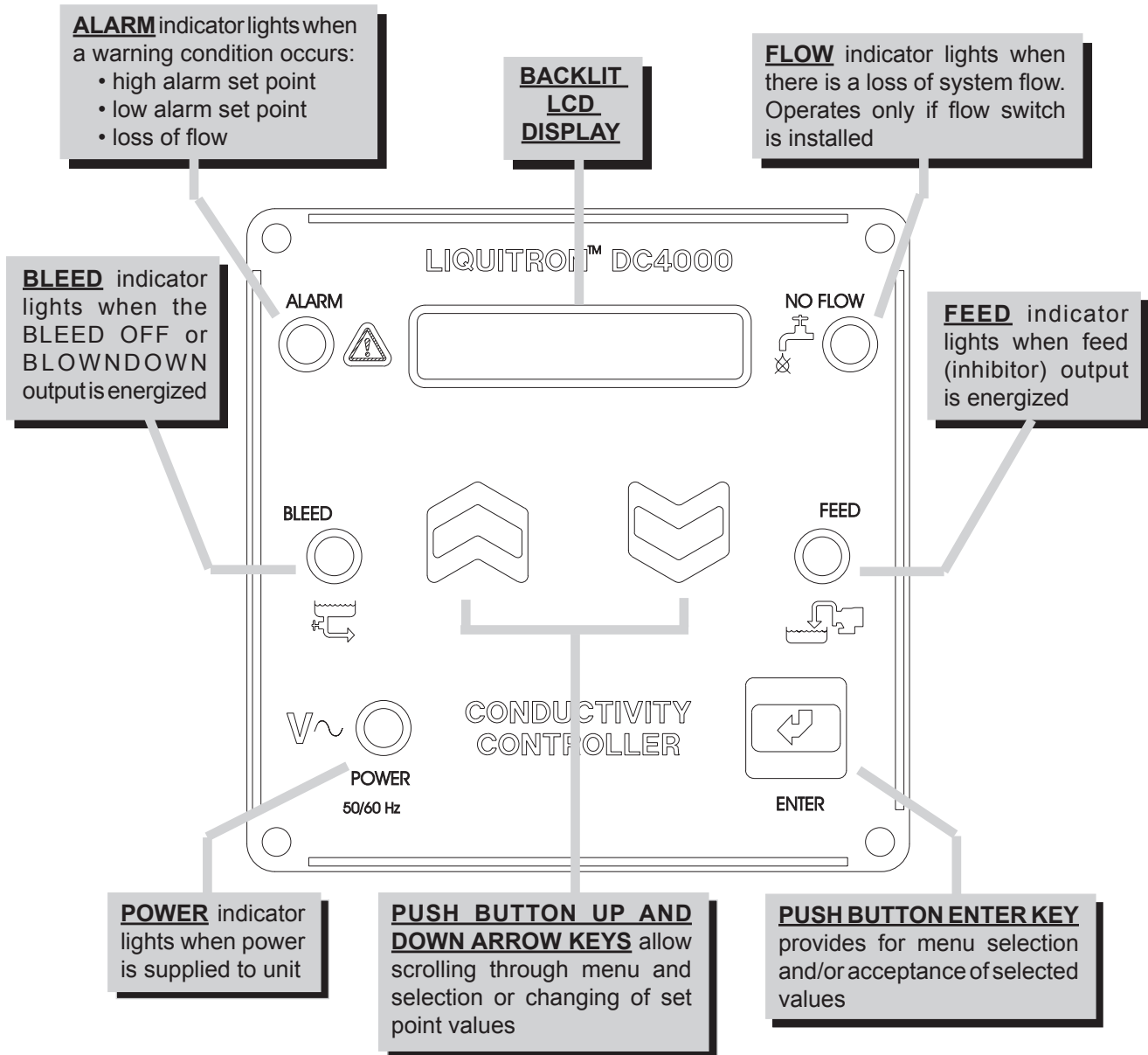

Figure 1

The controller operates in two (2) distinct modes, 'SYSTEM RUN' and 'SYSTEM START-UP' or 'PROGRAMMING MODE'. The unit will be in the 'SYSTEM RUN' mode when it is first turned on. The various program screen menus are used to calibrate the unit, set the control and alarm points, set the inhibitor feed operating parameters, and manually test the relays and wiring connections.

In the 'SYSTEM RUN' mode the DC4000 monitors the conductivity and activates the appropriate control or alarm relay as necessary based on the set points entered in the 'SYSTEM START-UP' mode.

The DC4000 is packaged in a NEMA 12X, flame-retardant, molded TPE enclosure. When ordered, 115 VAC units come fully wired to include input power cord and relay output pigtailed to allow for simple installation. The unit can be hardwired through conduit to the lower junction box portion of the enclosure when required. Hard wiring makes the unit suitable for NEMA 4X applications.

2.0 Installation

2.1 Mounting the Controller Enclosure

The DC4000 conductivity controller is supplied with integral wall-mounting flanges. It should be mounted with the display at eye level on a vibration free surface. All accessible mounting holes should be utilized. The maximum allowable temperature is 122° F [50° C]. This should be considered if installation is in a high-temperature location. Once the DC4000 is wall mounted, the metering pumps may be located at any distance from the controller. The conductivity probe should be placed as close to the controller as possible. Consult factory for distance over 30 ft [9 m]. Under 25 ft [7.6 m] is recommended. Over 30 ft [7.6 m], the cable may need to be isolated or shielded.

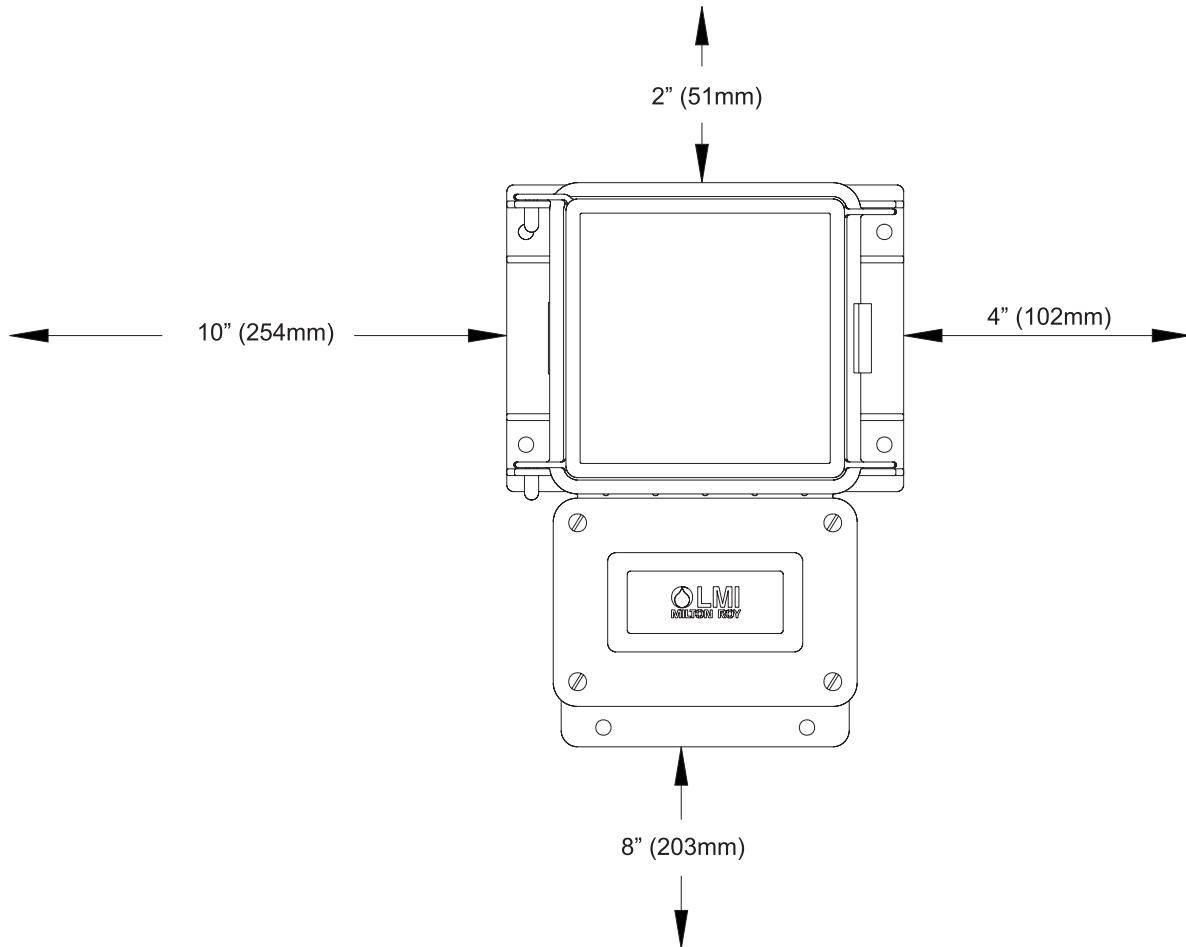

Figure 2

2.2 Enclosure Mounting Dimensions

When using the prewired unit, the enclosure is configured as NEMA 12X. If the unit is connected through watertight conduit, the enclosure is configured as NEMA 4X.

The following clearances should be observed for proper mounting (see Figures 2 and 3).

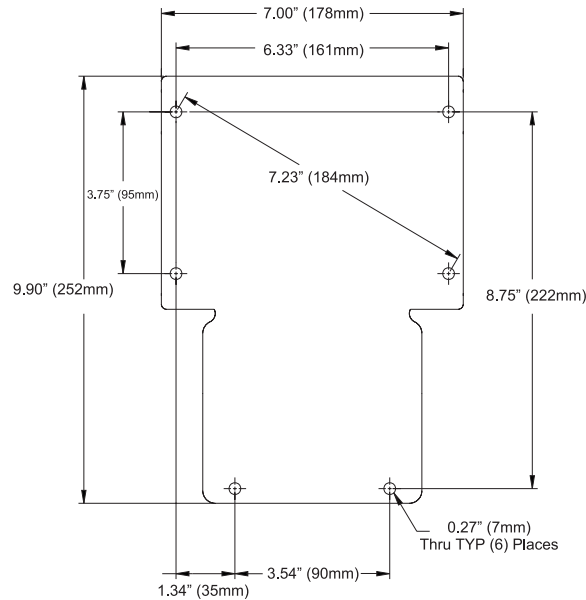

Figure 3

2.3 Electrical Wiring Information



To reduce the risk of electrical shock, the controller must be plugged into a grounded outlet with ratings conforming to the specifications on the data nameplate. It must be connected to a viable ground circuit. DO NOT USE ADAPTERS (see Figure 4)! All wiring must conform to required electrical codes.

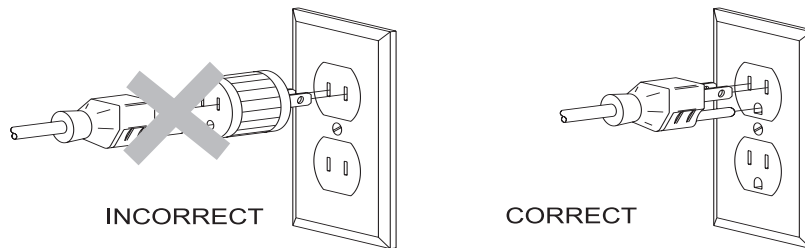

Figure 4

The DC4000 conductivity controller is available in either 115 or 230 VAC 50/60 Hz. The 115 VAC version is supplied with one (1) 6-foot grounded AC power cord and two (2) 12-inch output pigtails for plug-in connection of controlled devices.

A four-pin connector is provided for the temperature compensated (cooling tower mode) conductivity probe.



The DC4000 controller is provided with a voltage selector switch to allow the unit to be used with a 115 VAC or 230 VAC power source. To change the voltage selection, disconnect the unit from the power source and remove the front keypad panel. The selector switch is located on the circuit board attached to the back panel. When switching voltages ensure that power cord and pigtails are appropriately changed.

2.4 Terminal Strip Layout - DC4000

To access the wiring connections inside of the conductivity controller:

1. Disconnect the unit from electrical power.
2. Remove the four (4) screws and the junction box cover on the lower half of the unit.
3. Consult the specific instructions below for the connections required.

__AC Power Input

Hot:	TB4-1
Neutral:	TB4-2
Ground:	TB4-3

__Bleed / Blowdown / Control Relay Output

Hot (N.O.):	TB3-1
Hot (N.C.):	TB3-2
Neutral:	TB3-4
Ground:	To ground wire (twist connect) or GND post

Feed Output

Hot:	TB2-2
Neutral:	TB2-1
Ground:	To ground wire (twist connect) or GND post

__Alarm Output

Hot:	TB2-4
Neutral:	TB2-3
Ground:	To ground wire (twist connect) or GND post

__4 - 20 mA Output

(+)	TB6-1
(-)	TB6-2

2.4 Terminal Strip Layout - DC4000

___Flowmeter Input

The inputs are reversible when the flowmeter connection is a relay and has no polarity. Only use flowmeters that do not send power to the controller.

TB9-1

TB9-2

Flow Switch Input

This input can be used to connect a flow switch or other device providing a switch closure output. If a device such as this is connected to the DC4000, it will serve to disable the controller outputs when this switch is in the “OPEN” position.

This function can be used as a safety override to prevent controller/pump operation during loss of flow. This can be programmed to operate in the [N.O.] or [N.C.] configuration.

The electrical wiring inputs are reversible since the flow switch connection has no polarity.

TB9-3

TB9-4

___Thermistor Probe Input (If Hardwiring Cooling Tower Probe)

Run the thermistor probe wiring through the PG9 connector on the right side of the DC4000 controller junction box keeping the wires away from any 115/230 VAC cables that may cause electrical interference.

Signal Output: TB7-1

Signal Return: TB7-2

___Conductivity Probe (If Hardwiring Cooling Tower or Boiler Probe)

Run the conductivity probe wiring through the PG9 connector on the right side of the DC4000 controller junction box keeping the wires away from any 115/230 VAC cables that may cause electrical interference.

Signal Output: TB7-3

Signal Return: TB7-4

DC4000

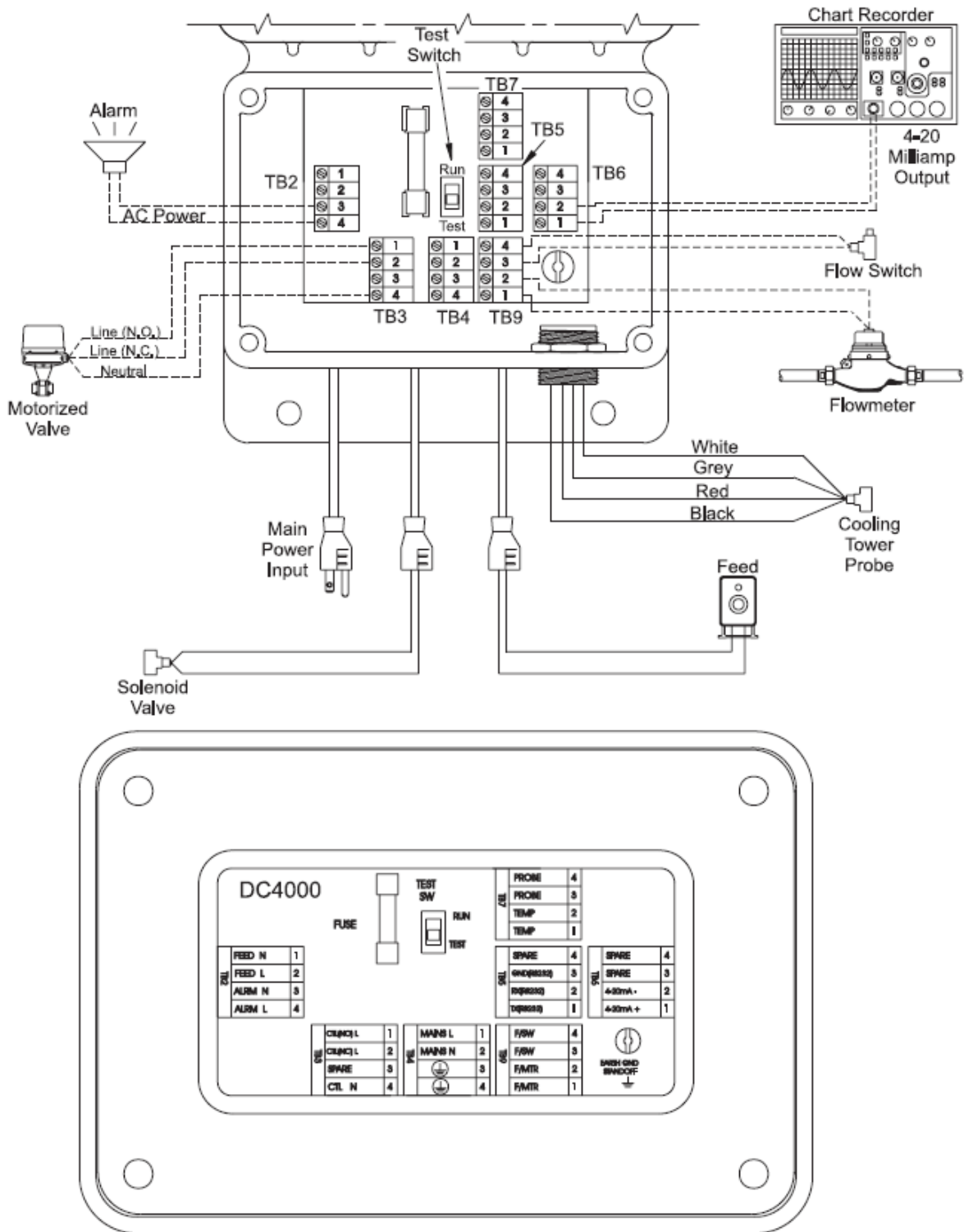

Terminal Strip Layout and Wiring Diagram for Accessories
Wiring diagram for Boiler Applications with 1/2" Conduit connections
Dotted lines represent HARDWIRED Accesories

Flowmeter Input DC4000

2.4 Terminal Strip Layout for CE-DC4000

To access the wiring connections inside of the conductivity controller:

1. Disconnect the unit from electrical power.
2. Remove the four (4) screws and the junction box cover on the lower half of the unit.
3. Consult the specific instructions below for the connections required.

AC Power Input

Hot: TB2-1

Neutral: TB2-3

Ground TB4-1

Bleed / Blowdown / Control Relay Output

Hot (N.O.): TB5-1

Hot (N.C.): TB5-2

Neutral: TB1-1

Ground: To ground wire (twist connect) or GND post

Feed Output

Hot: TB6-1

Neutral: TB2-4

Ground: To ground wire (twist connect) or GND post

Alarm Output

Hot: TB6-2

Neutral: TB1-2

Ground: To ground wire (twist connect) or GND post

4-20 mA Output

(+) TB9-1

(-) TB9-2

Flowmeter Input

The inputs are reversible when the flowmeter connection is a relay and has no polarity. Only use flowmeters that do not send power to the controller.

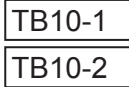

Flow Switch Input

This input can be used to connect a flow switch or other device providing a switch closure output. If a device such as this is connected to the DC4000, it will serve to disable the controller outputs when this switch is in the "OPEN" position.

This function can be used as a safety override to prevent controller/pump operation during loss of flow. This can be programmed to operate in the [N.O.] or [N.C.] configuration.

The electrical wiring inputs are reversible since the flow switch connection has no polarity.

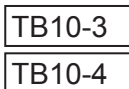

Thermistor Probe Input (If Hardwiring Cooling Tower Probe)

Run the thermistor probe wiring through the PG9 connector on the right side of the DC4000 controller junction box keeping the wires away from any 115/230 VAC cables that may cause electrical interference.

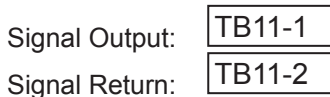

Conductivity Probe (If Hardwiring Cooling Tower or Boiler Probe)

Run the conductivity probe wiring through the PG9 connector on the right side of the DC4000 controller junction box keeping the wires away from any 115/230 VAC cables that may cause electrical interference.

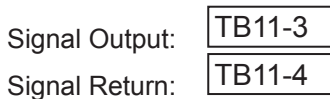

CE-DC4000

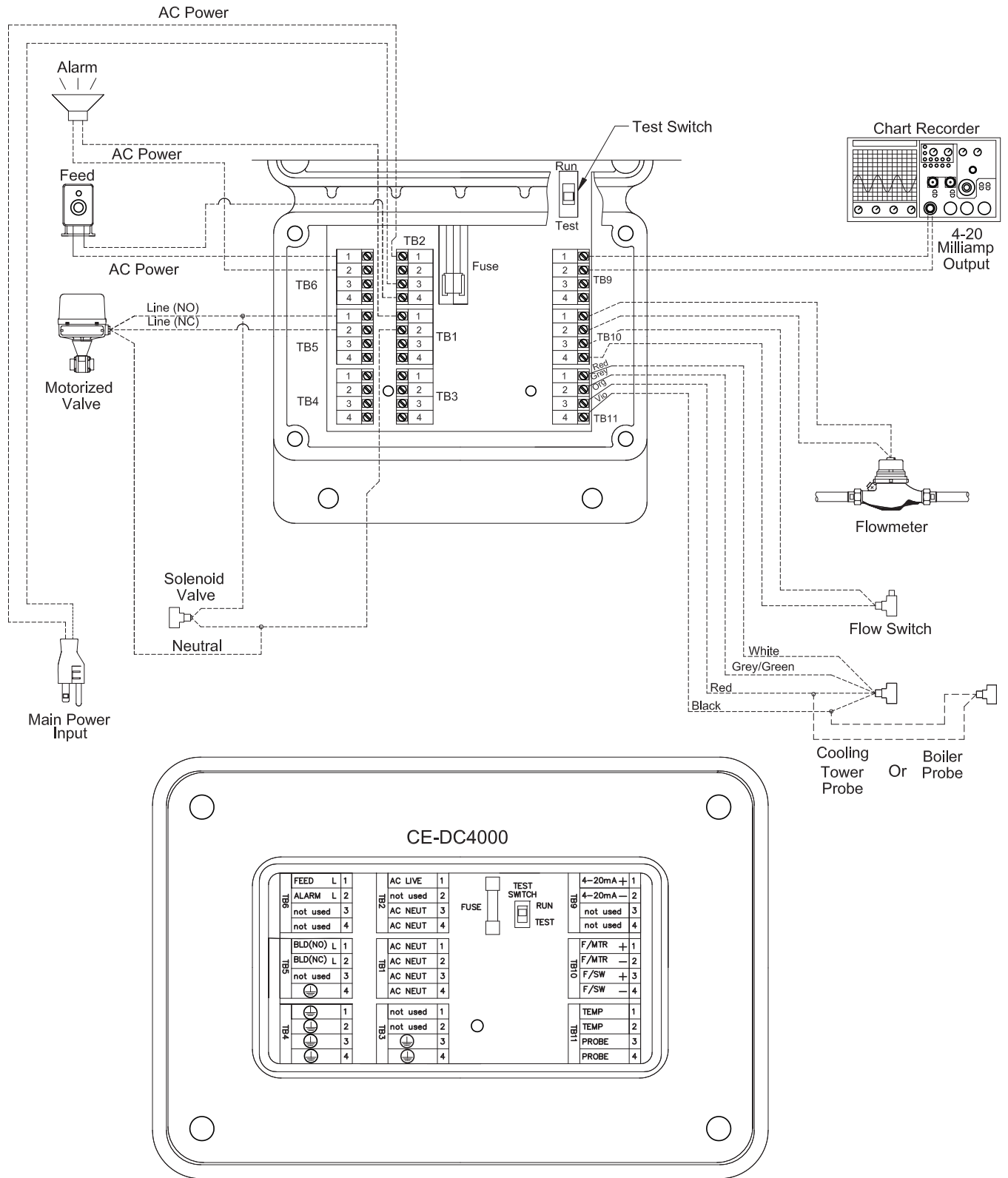

Terminal Strip Layout and Wiring Diagram for Accessories

Wiring Diagram for € version only

Dotted lines represent HARDWIRED Accessories

3.0 Operating the Controller



The Conductivity Read Screen or “System Run”:



COND : (μ S) 1470

The normal operating display for the DC4000 Series Controller is the conductivity reading screen (as shown above). This screen is referred to as “System Run” throughout this manual. The controller relay outputs cannot be activated unless the unit is in the “System Run” or conductivity reading mode. The only exception is when the unit is in the test mode.



After reviewing or changing the conductivity controller programming setpoints, the unit must be returned to the “System Run” or conductivity reading screen to allow automatic control to proceed. There are three ways to return to the “System Run” screen and mode:

1. Use the  or  keys to move through the various menus, and back to the “System Run” screen.
2. Push ANY two (2) keys simultaneously. This will return the unit immediately to the “System Run” screen.
3. The unit will return to the “System Run” screen automatically after three (3) minutes if no keys are pressed.

3.1 Menu Overview

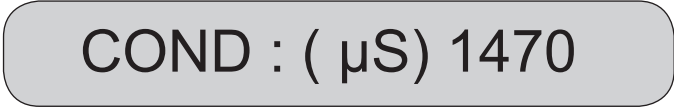
When the “System Run” screen is displayed in the window, the unit automatically switches to the run/operate mode of operation.



This “System Run” display line is the top menu page item. Pressing the  or  keys will move the display window to another line item. When not in the “System Run” mode the outputs to the control relays are disabled. The following is the order of items in the main menu:

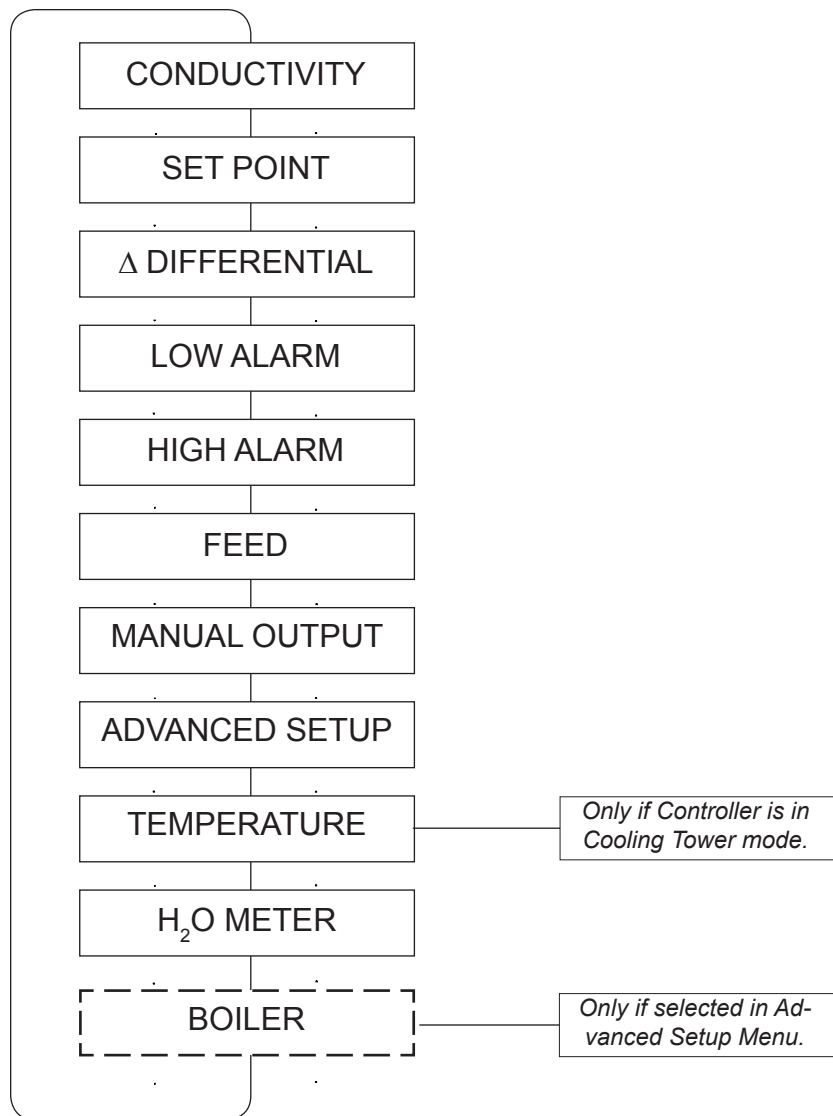

3.2 Conductivity

- CONDUCTIVITY
- SET POINT
- Δ DIFFERENTIAL
- LOW ALARM
- HIGH ALARM
- FEED
- MANUAL OUTPUT
- ADVANCED SETUP
- TEMPERATURE
- H₂O METER
- BOILER

COND : (μS)3400

Conductivity Reading Screen

The “CONDUCTIVITY” screen displays the conductivity readings in either μSiemens or PPM/TDS (parts per million/total dissolved solids). When the controller is displaying this screen it is considered to be in the SYSTEM RUN mode. This means that the pumps, solenoids, and alarm outputs will be activated based on the controller’s programmed set points. When the controller is in any other display screen all the outputs are disabled and will not be energized.

COND : (μS)3400 — ENTER — CAL: (μS) 3400

From Conductivity Screen....press Enter....to access Calibration

Pressing the “ENTER” key when the “CONDUCTIVITY” screen is displayed accesses the calibration mode. From this “CALIBRATION” screen the “UP” or “DOWN” keys can be pressed to change the conductivity reading and adjust for inaccuracies. If calibration adjustment is attempted beyond 50% of the probe conductivity reading, the controller will flash a warning on the screen: “CALIBRATION LIMIT”. This alerts the operator that the probe needs to be serviced.



If Controller is set up in Boiler mode the calibration limits are: -90% and +400%.

CAL : (μS) 1700 — ENTER — CALIBRATION LIMIT

If Calibration is attempted beyond limit....

.....a Calibration Limit screen will appear.

3.3 Set Point

SET PT 3000

Set Point Screen

The “SET POINT” screen allows access to the conductivity value that will energize the bleed output relay and allow for the opening of the bleed valve. The output trip setting may be changed in this screen. The relay can be programmed to respond to either rising or falling conductivity values (see “ADVANCED MENU” options under “TRIP”).

SET PT μ S 3200

Pressing “ENTER” from the main menu “SET POINT” screen accesses the conductivity reading trip value and allows the value to be changed. The value will have a flashing cursor indicating that it can be changed. Press the “UP” or “DOWN” key to increase or decrease the value. Press “ENTER” to save the value.

- CONDUCTIVITY
- SET POINT**
- Δ DIFFERENTIAL
- LOW ALARM
- HIGH ALARM
- FEED
- MANUAL OUTPUT
- ADVANCED SETUP
- TEMPERATURE
- H₂O METER
- BOILER

3.4 Δ Differential

CONDUCTIVITY

Δ DIFF 100

SET POINT

Differential or Dead Band

Δ DIFFERENTIAL

The “DIFFERENTIAL” or dead band setting allows for a hysteresis to be programmed in to the conductivity trip point. A programmed hysteresis value prevents the bleed relay and solenoid from cycling on and off repeatedly when the conductivity reading hovers around the trip set point. The value entered in the “DIFFERENTIAL” is the amount of conductivity, away from the trip “SET POINT”, that the bleed relay will shut off.

LOW ALARM

Δ DIFF 100

HIGH ALARM

FEED

MANUAL OUTPUT

Press “ENTER” from this screen to change the value. The value will have a flashing cursor indicating that it can be changed. Press the “UP” or “DOWN” key to increase or decrease the value. Press “ENTER” to save the “DIFFERENTIAL” value.

ADVANCED SETUP

TEMPERATURE

H₂O METER

BOILER

CONDUCTIVITY SET POINTS

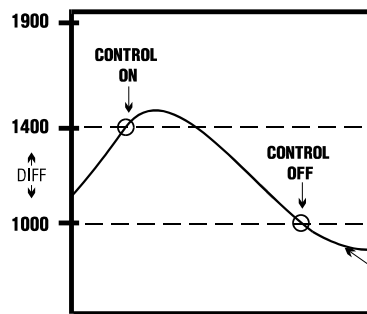

RISING SET POINT

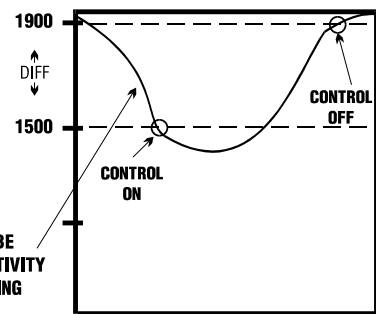

FALLING SET POINT

3.5 Low Alarm

LO ALARM 250

Low Conductivity Alarm Set Point

The “LOW ALARM” screen allows programming of the Low Conductivity reading that activates an alarm LED and output relay.

LO ALARM 250

Press “ENTER” from “LOW ALARM” screen to change this value. The setting will have a flashing cursor indicating that the value can be changed. Press the “UP” or “DOWN” key to increase or decrease the setting. Press “ENTER” to save the value.

- CONDUCTIVITY
- SET POINT
- Δ DIFFERENTIAL
- LOW ALARM**
- HIGH ALARM
- FEED
- MANUAL OUTPUT
- ADVANCED SETUP
- TEMPERATURE
- H₂O METER
- BOILER

3.6 High Alarm

CONDUCTIVITY

HI ALARM 4000

SET POINT

High Conductivity Alarm Set Point

Δ DIFFERENTIAL

The “HIGH ALARM” screen allows programming of the High Conductivity reading that activates an alarm LED and output relay.

LOW ALARM

HIGH ALARM

FEED

HI ALARM 4000

MANUAL OUTPUT

ADVANCED SETUP

Press “ENTER” from “HIGH ALARM” screen to change this value. The setting will have a flashing cursor indicating that the value can be changed. Press the “UP” or “DOWN” key to increase or decrease the setting. Press “ENTER” to save the value.

TEMPERATURE

H₂O METER

BOILER

3.7 Feed

FEED (MODE)

Feed Pump Screen

The “FEED” screen displays the current Inhibitor Feed Pump mode selected. There are four different FEED modes that may be selected from. The current active mode is displayed in parenthesis. The four possible modes to select from are:

- 1.) **Water Meter Pulse** Pump output based on flow meter input.
- 2.) **Feed as % of Time** Continuous pump output based on a repeating cycle timer.
- 3.) **Feed as % of Bleed** Feed after Bleed with a limit timer to control maximum pump run time. Pump output run time is based on a % of the total Bleed time.
- 4.) **Feed and Bleed** Feed and Bleed simultaneously with limit timer to control maximum feed pump run time.

Pressing the “ENTER” key from the main menu screen “FEED” (*Mode*) accesses the FEED sub-menu selections. Use the “UP” or “DOWN” key to scroll through the four different modes.

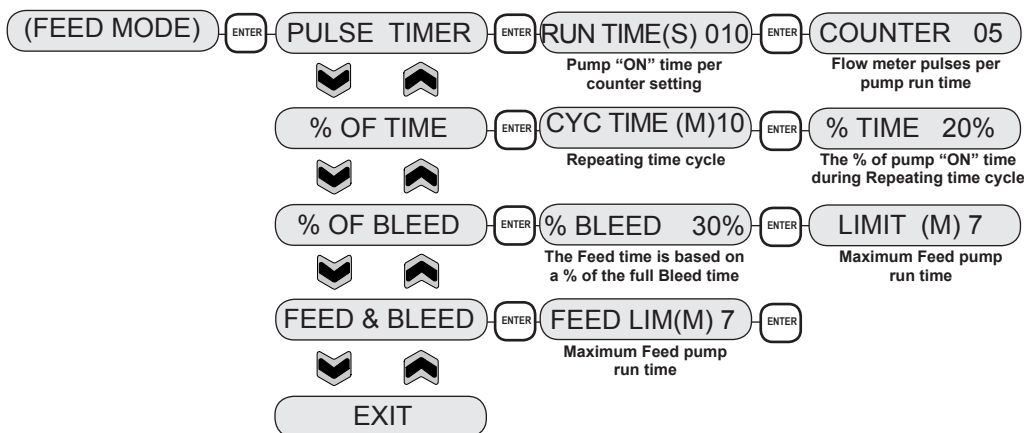

- CONDUCTIVITY
- SET POINT
- Δ DIFFERENTIAL
- LOW ALARM
- HIGH ALARM
- FEED**
- MANUAL OUTPUT
- ADVANCED SETUP
- TEMPERATURE
- H₂O METER
- BOILER

When the mode desired is displayed on the screen press “ENTER” to access the particular settings for that mode. The variables and settings that are available for each option are shown above. Use the “UP” or “DOWN” key to change the settings and press “ENTER” to save that setting.

3.8 Manual Outputs

- CONDUCTIVITY
- SET POINT
- Δ DIFFERENTIAL
- LOW ALARM
- HIGH ALARM
- FEED
- MANUAL OUTPUT**
- ADVANCED SETUP
- TEMPERATURE
- H₂O METER
- BOILER

MANUAL OUTPUT

Manually Energize Relay Outputs

The “MANUAL OUTPUTS” mode is provided to allow for manual energizing of each relay output. Once the external devices have been connected, they may be individually or collectively energized and tested. Testing of all these components is recommended after system installation and prior to system start up. Press “ENTER” to access these sub-menu screens. Press the “UP” or “DOWN” key to move to each relay control screen. Press “ENTER” from each relay output screen to energize that output relay. Press “ENTER” a second time to de-energize that relay. One or all of the relays may be energized in this manner. The output relays will be de-energized if:

- (1) No keys are pressed for 3 minutes and the controller returns to the “SYSTEM RUN” screen.
- (2) The operator manually de-energizes each relay output.
- (3) The operator manually exits the “MANUAL OUTPUT” sub-menu screens.

Main Screen

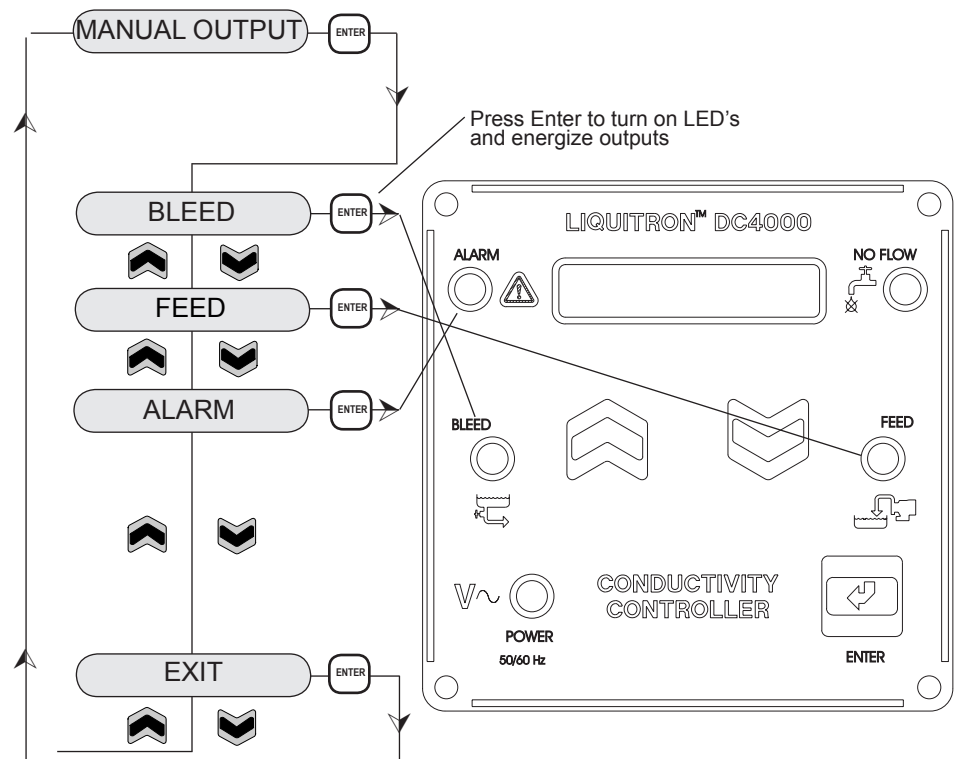

3.9 Advanced Setup

ADVANCED SETUP

The “ADVANCED SETUP” screens allow for the special configuring of the controller for advanced options. These options include:

- FLOW ALARM (energizing the alarm output relay on loss of flow);
- FLOW SENSE (under FLOW ALARM) the response of the flow switch may be changed from either normally open or normally closed logic;
- TRIP (bleed based on either rising or falling conductivity trip point);
- 4 - 20 mA recorder output programming;
- Conductivity units DISPLAY may be either μ Siemens or PPM/TDS;
- BLEED control (Boiler or Cooling Tower); and
- LOAD DEFAULTS.

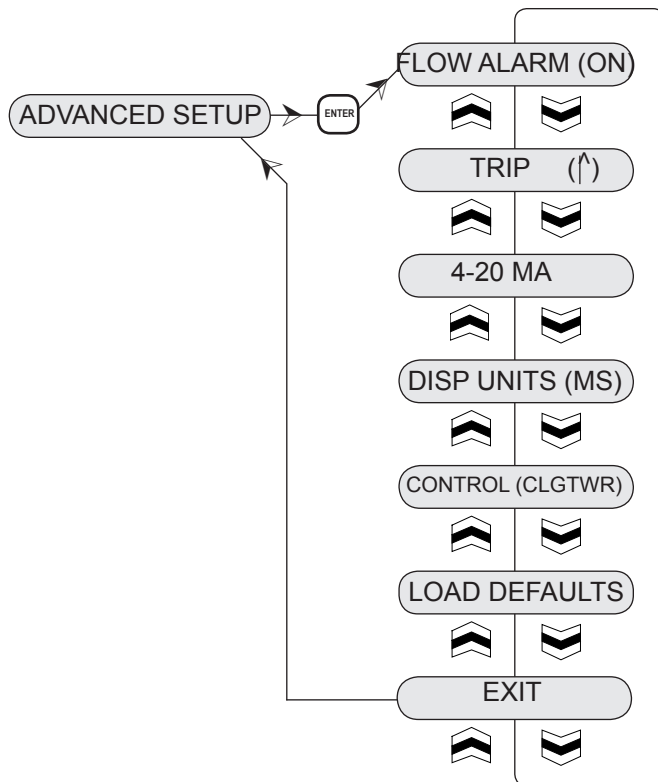

CONDUCTIVITY

SET POINT

Δ DIFFERENTIAL

LOW ALARM

HIGH ALARM

FEED

MANUAL OUTPUT

ADVANCED SETUP

TEMPERATURE

H₂O METER

BOILER



3.10 Temperature

- CONDUCTIVITY
- SET POINT
- Δ DIFFERENTIAL
- LOW ALARM
- HIGH ALARM
- FEED
- MANUAL OUTPUT
- ADVANCED SETUP
- TEMPERATURE**
- H₂O METER
- BOILER

TEMP (F) 032°

The “TEMPERATURE” screen displays the temperature sensed by the externally connected thermistor [10K Ohms at 77° F / 25° C] in the Cooling Tower probe. The screen may display temperature in either Degrees (F) or Degrees (C). Pressing “ENTER” from this screen accesses this option change. Pressing the “UP” or “DOWN” key toggles between displaying °F or °C. Pressing “ENTER” a second time saves the displayed Temperature selection.



Use  or  key
to change from °C
to °F



*Temperature will not be displayed in the Boiler mode.
Default Temperature in Boiler Mode is 25°C.*

3.11 H₂O Meter

TOTAL (00000) GAL

Water Meter Totalizer Screen

The “WATER METER TOTAL” screen allows for the display of the total gallons accumulated through a flow meter. The submenu allows for the programming of the: 1) water meter pulses-to-gallons (liters) ratio; and 2) reset of the totalizer back to zero. The maximum accumulation is 65,000 gallons (liters).

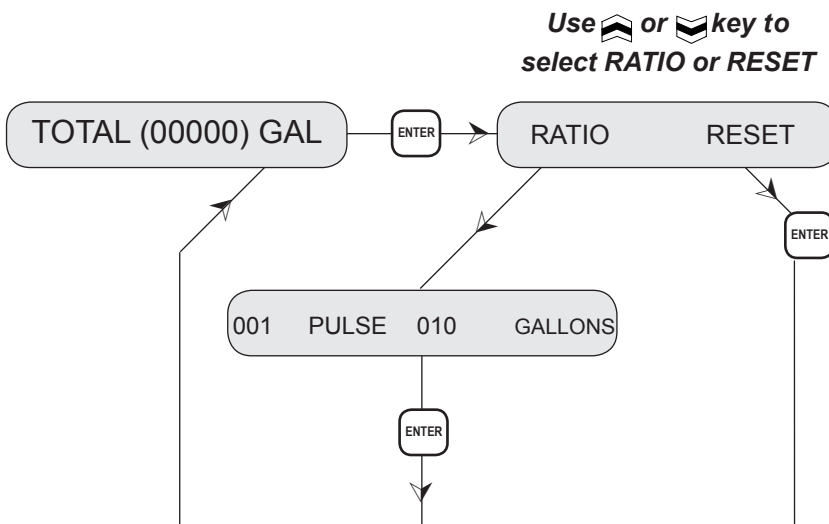

CONDUCTIVITY

SET POINT

Δ DIFFERENTIAL

LOW ALARM

HIGH ALARM

FEED

MANUAL OUTPUT

ADVANCED SETUP

TEMPERATURE

H₂O METER

BOILER

3.12 Boiler

The DC4000 Controller is shipped from the factory set in the “COOLING TOWER” mode. Select “BOILER” mode in “ADVANCED” menu to change this.

- CONDUCTIVITY
- SET POINT
- Δ DIFFERENTIAL
- LOW ALARM
- HIGH ALARM
- FEED
- MANUAL OUTPUT
- ADVANCED SETUP
- TEMPERATURE
- H₂O METER
- BOILER

- CONDUCTIVITY
- SET POINT
- Δ DIFFERENTIAL
- LOW ALARM
- HIGH ALARM
- FEED
- MANUAL OUTPUT
- ADVANCED SETUP
- TEMPERATURE
- H₂O METER
- BOILER

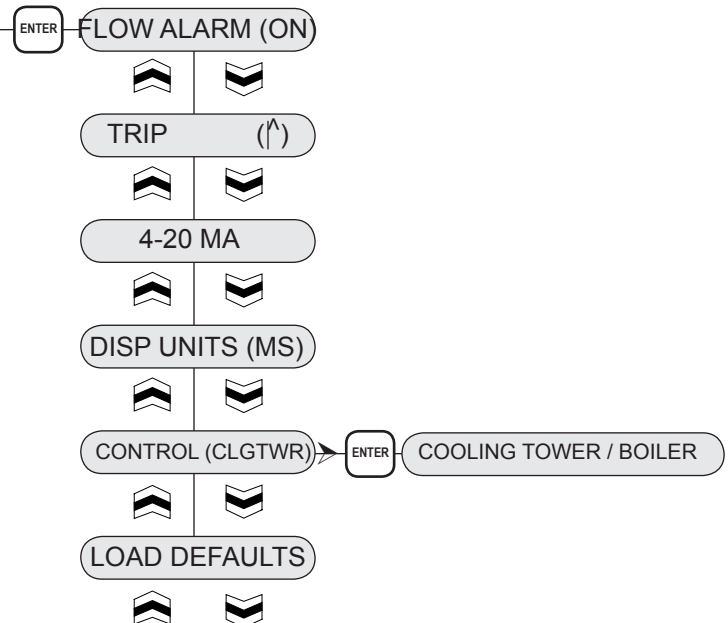

Now the “BOILER” screen will appear in the “MAIN” menu. Navigate to this screen.



Use or to toggle from “CONTINUOUS” or “TIMED” conductivity sampling. Press to select that mode.

- If “CONTINUOUS” sampling is selected, proceed to Section 4 “Continuous Sampling Start-Up”.
- If “TIMED” sampling is selected, the operator will then have the following options:

3.12 Boiler (cont'd)

SAMPLE TIME 12 (MINUTES) **ENTER** DURATION 120 SECONDS

Boiler OFF time

Boiler Blowdown time

If “TRAP SAMPLE” is selected for “TIMED SAMPLING”, the operator will be prompted to program the amount of trap time.

TRAP TIME 120 SECONDS

The “TRAP TIME” allows for a delay period before the controller reacts to the conductivity readings. At the beginning of the trap, the motorized blowdown valve is closed. The controller then counts down the programmed “TRAP TIME”. At the end of the “TRAP TIME” the control then reads the conductivity and reacts on it. This delay, or “TRAP TIME”, allows any ‘flashed’ boiler water or steam to be re-compressed. This eliminates any erroneous conductivity readings from flashed steam.

CONDUCTIVITY

SET POINT

Δ DIFFERENTIAL

LOW ALARM

HIGH ALARM

FEED

MANUAL OUTPUT

ADVANCED SETUP

TEMPERATURE

H₂O METER

BOILER

The DC4000 can be programmed for a variety of different tasks. Before start-up can be completed, certain information must be decided regarding the controller programming.

The following work sheet should be filled out in advance to aid in the programming of the controller.

The single most important decision is whether the controller will be used for cooling tower, boiler, or closed loop control. If operation is not cooling tower or continuous sample boiler, the set-up menu will be used to select falling trip point for closed loop systems or to select the boiler mode.

4.2 Pre-Start-Up Work Sheet

<p>Pre-Start-Up Work Sheet</p> <ol style="list-style-type: none">1. Current system conductivity in μS _____2. Desired conductivity set point in μS _____3. Differential value (range) in μS _____4. Method of chemical feed to be used _____<ol style="list-style-type: none">a.) External (PULSE): 0-999 seconds run - time, 1-100 counterb.) % of TIME: 0-100 minute cycle, 1-100% of timec.) % of control (BLEED): 1-100% of controld.) Limit (FEED and BLEED): 1-999 minutes5. Feed timer setting _____ min/sec/cycle6. High alarm setting _____7. Low alarm setting _____8. If flow switch is used, does it activate the alarm when flow is lost? YES NO
--

Once the operating settings and parameters have been determined by the data entered above, the DC4000 Controller can then be programmed. Supply power to the controller. Read the conductivity and verify the accuracy using a calibrated meter and conductivity sample. Calibrate the controller as needed. See Calibration section.



In the Main Menu, enter the required values for Conductivity, Differential, Low Alarm and High Alarm/. Go to the FEED menu screen (see FEED programming sheet in manual) and enter the required mode and settings for the chemical inhibitor pump control.

Go to the SET UP menu screen (see SET UP programming sheet in manual) and enter the Flow Alarm Option, Trip Actuation, 4 - 20 mA settings, Display Mode, and Control Cooling Tower/Boiler Mode.

Use the MANUAL OUTPUTS menu (see MANUAL OUTPUTS programming sheet in manual) to check that all controlled devices are properly connected.

This completes the cooling tower start-up. Return the display to the 'SYSTEM RUN' or 'CONDUCTIVITY Reading' screen to begin operation.

The system will return to the 'SYSTEM RUN' mode automatically on its own after three (3) minutes if no keys are pressed.

4.3 Boiler Installation

The DC4000 controller when used for boiler conductivity control can be set up in two different operating modes:

- Timed sampling
- Continuous sampling

The choice of which mode to use is important. As a rule of thumb, if the blowdown requirement of the boiler is greater than 5000 lbs/hr, the boiler may be continuously sampled. Since the boiler sample is sent to drain and not returned to the system, continuously sampling a smaller (less than 5000 lbs/hr blowdown requirement) boiler can result in excessive blowdown.

Timed sampling is the best mode to select when the blowdown requirement will be less than 5000 lbs/hr. The controller allows only periodic samples of boiler water to pass the electrode. If the sample is high in conductivity, the sampling period will extend until the conductivity falls below preset levels. Once the conductivity is below the set point, including differential, the periodic sampling will resume at the preset intervals.

4.4 Determining the Blowdown Requirement

If the blowdown requirement for your particular boiler is unknown, it can be approximated by knowing the following data and applying the formula below:

Data Required

H.P. = Boiler Horsepower

% Condensate = % of Condensate Return to Boiler

Cycles = Cycles of Concentration

Formula

- H.P. x 34.5 = Steam Output (lbs./hr)
- Steam Output (lbs/hr) x $(1 - \frac{\text{Condensate}}{100\%})$ = Make-Up Req. (lbs/hr)
- Make-Up Req. (lbs/hr) x $(\frac{1}{\text{Cycles} - 1})$ = Blowdown Req. (lbs/hr)

Example

A 200 horsepower boiler returning 50% condensate operating at 4 cycles of concentration.

- 200 H.P. x 34.5 = 6,900 lbs/hr Steam Output
- 6,900 lbs/hr x $(1 - \frac{50\%}{100\%})$ = 3,450 lbs/hr Make-Up Req.
- 3,450 x $(\frac{1}{4-1})$ = 1,150 lbs/hr Blowdown Req.

4.5 Timed Sampling Mode

Used in small to medium sized boilers where the blowdown requirements are less than 5000 lbs/hr. A boiler this size or smaller cannot be sampled continuously because the volume of water (blowdown) lost to sampling would prevent the conductivity from rising above the set point.

The controller utilizes an internal timing circuit to open a blowdown valve at periodic intervals. When the valve opens, the unit reads the conductivity. The controller reacts to the conductivity reading only while this valve is open. If the conductivity is above the preset level, defined as set point including differential, the system will continue to blowdown until the conductivity drops below the preset level.

There is a 'Trap Sample' programming menu option provided for under the timed boiler sampling. This option allows a boiler water sample to be temporarily trapped near the probe so that any flashed steam can settle out and be recompressed. This prevents erratic conductivity readings from occurring.

If 'Trap Sample' is selected as 'N' or 'no' then this option is not enabled and conductivity will be read at the end of the sample duration time.

If 'Y' or 'yes' is selected, then this option is enabled and the blow down valve will be temporarily closed for the amount of programmed 'Trap Time'. The boiler water sample will settle out during this time. At the end of the 'Trap Time' the conductivity will be read and reacted on. If the conductivity is below the set point, the controller will start another 'Off Time' cycle. If the conductivity is above the set point, the controller will conduct another blow down or 'Duration' cycle time.

4.6 Continuous Sampling

For large boilers with a blowdown requirement in excess of 5000 lbs/hr. The controller constantly monitors system conductivity with the sample going to drain.

When the conductivity exceeds preset limits, defined as set point including differential, the controller activates a motorized or solenoid valve on an auxiliary blowdown line. When the conductivity drops below the set point (including differential), the valve closes.

4.7 Boiler Installation Notes

LMI provides the controller, an optional sampling probe, and probe mounting cross. The conductivity electrode provided can be installed to temperatures of up to 400° F (205° C) and pressures of 250 psi (17.3 Bar). Temperatures and pressures exceeding these extremes will require the use of a sample cooler and/or other probes. Check that all other valves installed to complete this installation have a high enough pressure and temperature rating.

Additional equipment required to complete installation for a TIMED sample method of control:

1. **Fully ported shut off valve for blowdown line.** Allows the electrode to be removed from the system while the boiler is on.
2. **Adjustable flow control valve or orifice union and various sized plates.** Controls blowdown rate and insures back pressure at the electrode.
3. **Motorized or solenoid operated valve, normally closed.** Controls the opening and closing of the blowdown line.
4. **One quarter (1/4) turn mechanical ball valve.** For flushing the probe line.

Additional equipment required to complete installation for a CONTINUOUS sample method of control:

1. **Fully ported shut off valve for blowdown line.** Allows for the removal of the electrode while the boiler is on.
2. **Adjustable flow control valves or orifice unions with various sized plates.** Controls sampling rate, blowdown rate, and ensures back pressure at the electrode to prevent flashing.
3. **Motorized or solenoid operated valve, normally closed.** Controls the opening and closing of the auxiliary blowdown line.
4. **One quarter (1/4) turn mechanical ball valve.** For flushing the probe line.

4.8 Boiler Start-Up

Determine if the application requires timed or continuous sampling as per the sizing information in this manual.

4.9 Timed Sample Start-Up

1. Check that the unit is installed as shown in Figure 7 Timed Sample on page 30.
2. Complete the Pre-Start-Up Work Sheet on page 26.
3. Supply power to the DC4000 controller.
4. Place the unit in the Manual Output mode and activate the control relay. This will test the motorized blowdown valve.
5. Take a boiler water sample and calibrate as needed.



Wait until the reading stabilizes before adjusting the calibration.



The interval should be frequent enough to ensure that conductivity levels don't rise too high between samples

The sample duration should be long enough to allow the reading on the display to stabilize before the sample period ends. A good starting point is a sample interval of 30 minutes and a duration of 60 seconds. Make any other needed changes in **Set-Up**.

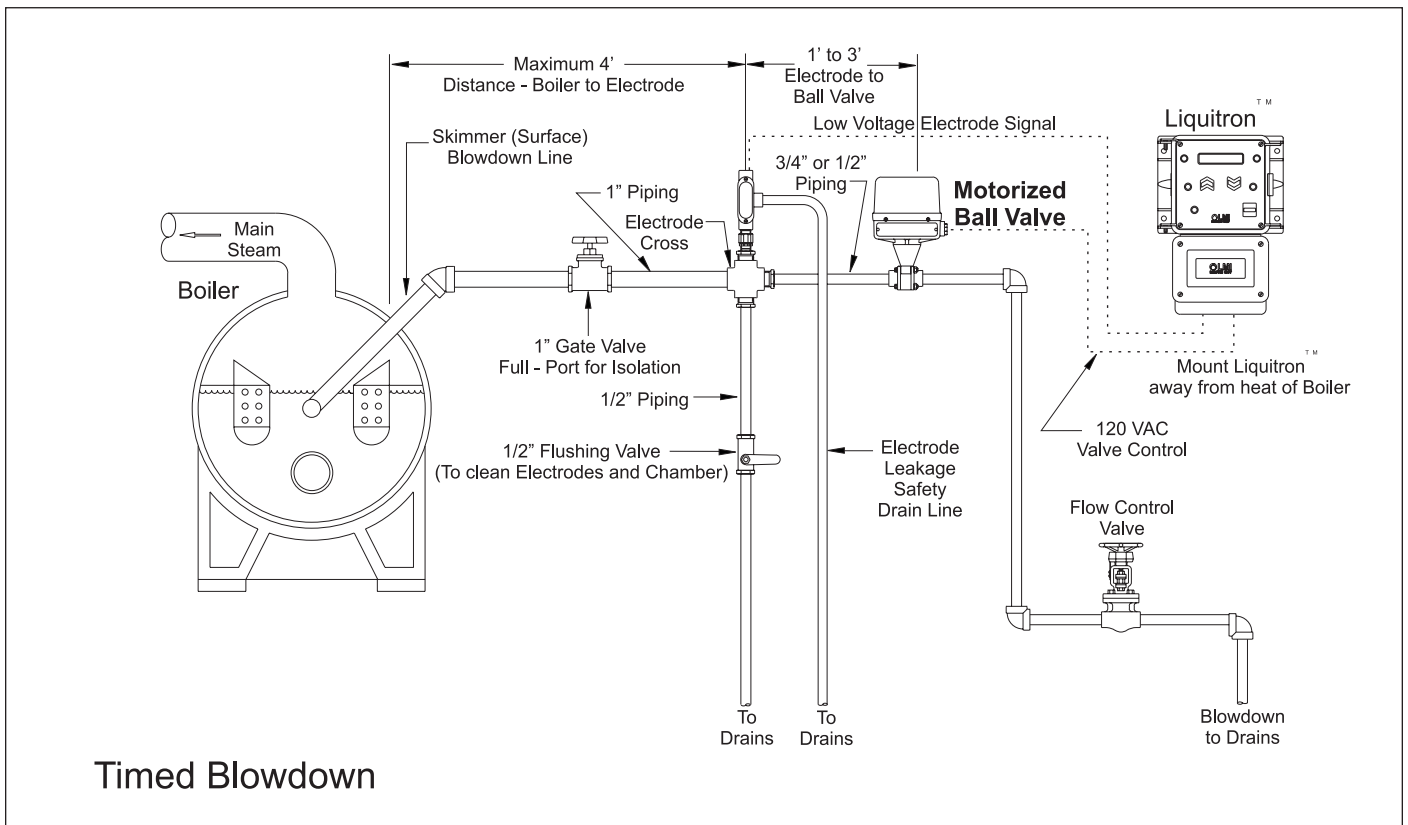

Figure 7: Timed Sample

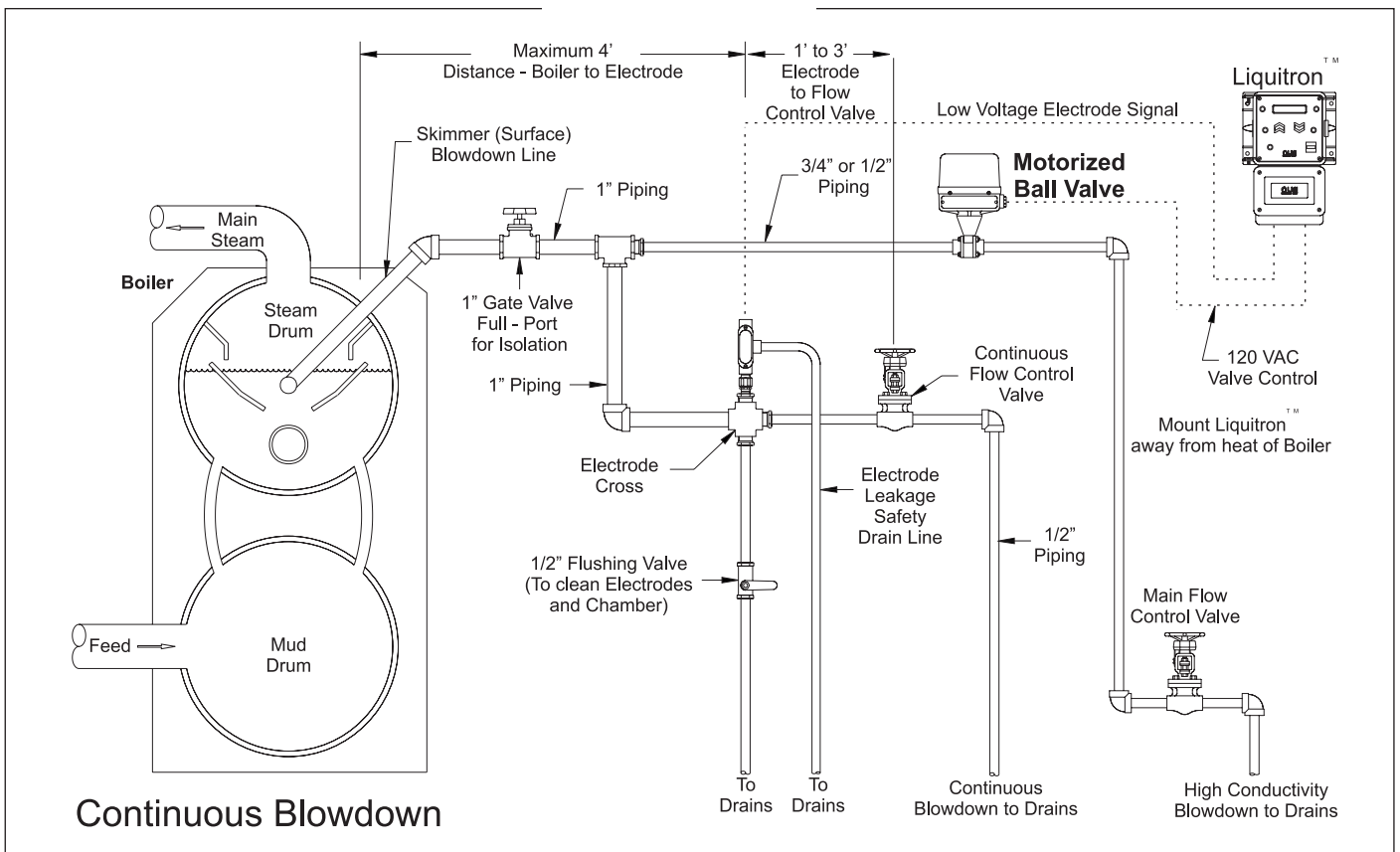









Figure 8: Continuous Sample

4.10 Continuous Sample Start-Up

1. Check that the unit is installed as shown in Figure 8 Continuous Sample on page 30.
2. Complete the Pre-Start-Up Work Sheet on page 26.
3. Supply power to the DC4000 controller, read the conductivity and verify accuracy using a calibrated meter and sample. Calibrate as needed.
4. Go to the **Set-Point** screen and enter the desired conductivity set point.
5. Go to the Differential screen and enter the desired deadband.
6. Go to the High and Low Alarm screens and enter the desired values.
7. Go to the **Feed** screen and press . Use the  and  keys to move to the type of feed desired. Press  to select that mode. Use the  and  keys to set the correct feed times or percentages for your application. Press  to save that setting. Now the feed screen will display with the feed mode you selected.
8. Use the **Test** menu to check all controlled devices (i.e. pumps, valves, alarm devices) are properly connected. See test section for directions.
9. Return the unit to the Conductivity “System Run” screen. This completes the start-up sequence for continuous sampling boiler operation.

4.11 Closed Loop Installation Theory of Operation

The DC4000 can be configured with a reverse or falling set point to allow for control of chemical levels in closed loop systems. Unlike cooling towers and boilers that respond to a rising conductivity set point to control bleed off, the closed loop mode enables the unit to respond to a falling set point to control chemical feed.

The DC4000 is installed to monitor the system conductivity. Whenever the conductivity drops due to the addition of make-up water, the DC4000 will turn on a chemical feed pump which will cause the conductivity to rise. When the conductivity returns to the proper level (set point plus differential) the chemical feed pump will shut down, and wait for the addition of more make-up water.

4.12 Closed Loop Start-Up

1. Check that the unit is installed as shown in Figure 9 on page 32.
2. Complete the Pre-Start-Up Work Sheet on page 26.
3. Supply power to the DC4000 controller. Read the conductivity and verify accuracy. Calibrate as needed.
4. The Bleed or Control Output is now used to power a pump.
5. Go to the **Set Point** screen and enter desired pump (bleed) energizing value.
6. Generally no differential or deadband is used: none is required for a pump. Program High / Low Alarm as desired.
7. The Manual Outputs menu screen should be used to test outputs.
8. Return the unit to the Conductivity screen or “System Run” . This completes the start-up sequence for closed loop operation.

4.13 Closed Loop Installation Notes

As in a cooling tower application, the probe should be installed in a bypass sample stream. The probe should be isolated by valves to allow for removal while the system is on. Any chemical injection must take place downstream of the probe.

Refer to Figure 9 below for location of components.

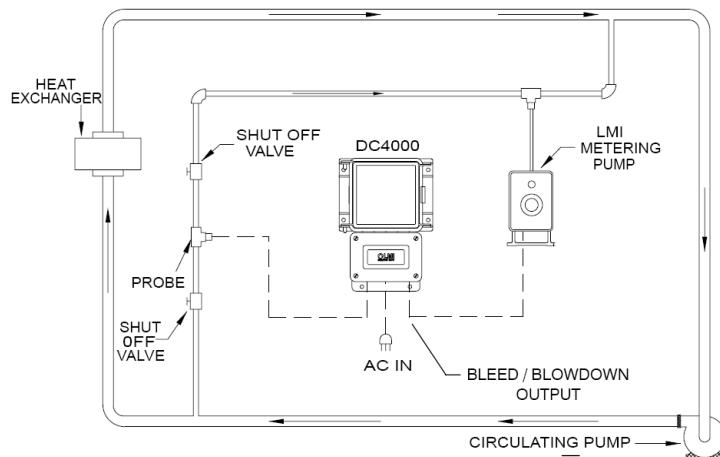





Figure 9: Closed Loop Installation

5.0 Functional Instructions

5.1 Calibration

Calibration will be required during Start Up or when a discrepancy exists between the displayed conductivity value and the conductivity value determined by a reliable alternative such as an accurate hand held tester.

1. Check that the conductivity probe is clean. See Section 7.1 for cleaning instructions.
2. From the “System Run” Conductivity screen, press . “CAL :” will be displayed along with the current conductivity.
3. Use the  and  keys to change the display to correspond with the conductivity reading from the hand held tester. Press .



This locks in the number entered on the display, and completes the conductivity calibration procedure.

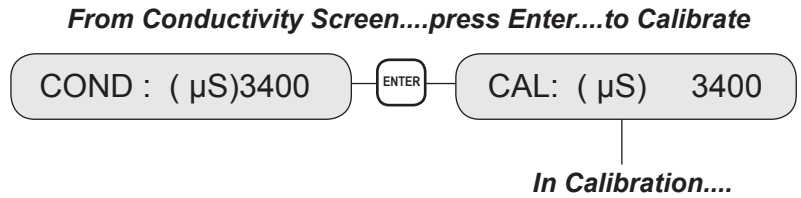

If the probe reading is off by more than 50%, then the controller will indicate an error by displaying 'CAL LIM μ S'. This generally means that the probe has failed or needs cleaning.

Alternately, a sample of cooling tower water may be analyzed by a precalibrated conductivity monitor, and the DC4000 controller calibrated to match that reading using the sample as a standard solution.



- 1) press  or  to adjust conductivity reading value
- 2) press  to save calibrated conductivity value

The DC4000 Controller provides a circuit board test-switch to aid in troubleshooting the unit and system. The switch is located under the access cover on the lower section of the controller (see Figure 10).

The conductivity test-switch allows the user to determine if the conductivity circuit is operating correctly. When placed in the test position, this switch switches the conductivity probe and wiring out of the circuit and places an internal precision resistor. This resistor has a known conductivity reading of 3000 μ S +/- 5%. If the unit has been calibrated then this reading could be displayed as + or - 50% of this 3000 μ S value (+4500 μ S, -1500 μ S).

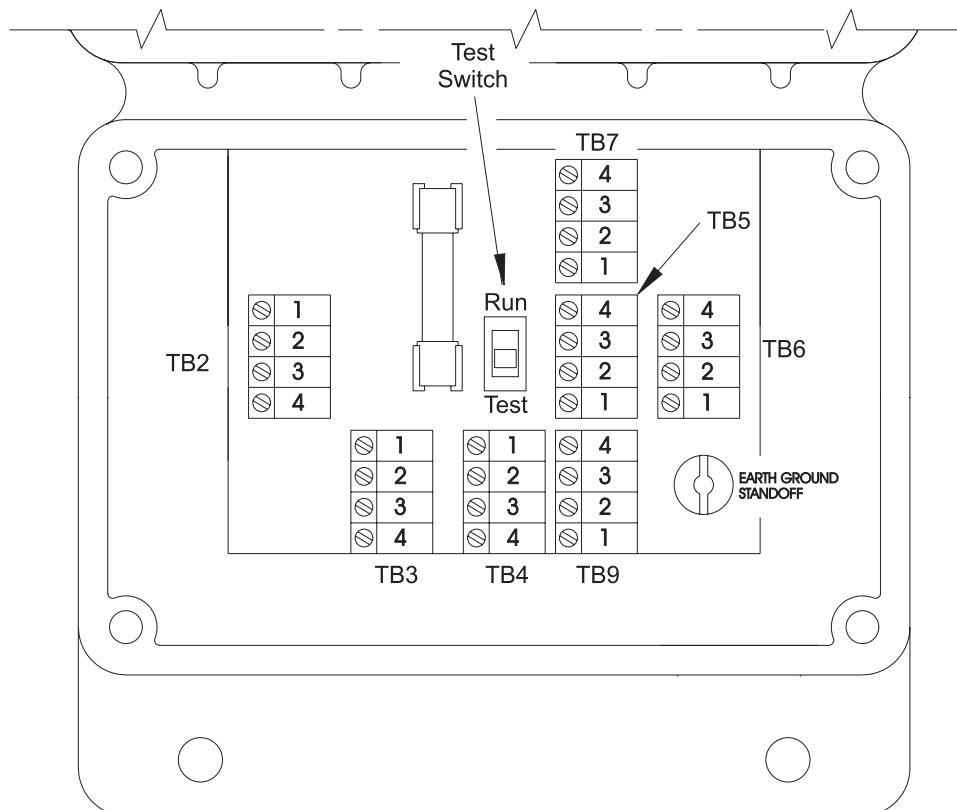

Figure 10: Test Switch

6.0 Maintenance

6.1 Controller

The DC4000 controller itself requires very little maintenance. Wiping the controller down with a damp cloth will clean it. Do not spray down the controller unless the enclosure door is closed and latched.

6.2 Probe



The controller must be recalibrated after cleaning the probe.

Cleaning Procedure

The probe can normally be cleaned using a cloth or paper towel and a mild cleaning solution such as **409** cleanser. Occasionally, a probe may become coated with various substances which require a more vigorous cleaning procedure. Usually the coating will be visible, but not always. To clean a coated probe, use a fine grit abrasive, such as emery paper. Lay the paper on a flat surface and move the probe in a back and forth motion as shown in Figure 11. The probe should be cleaned parallel to the carbon electrodes, NOT perpendicular.

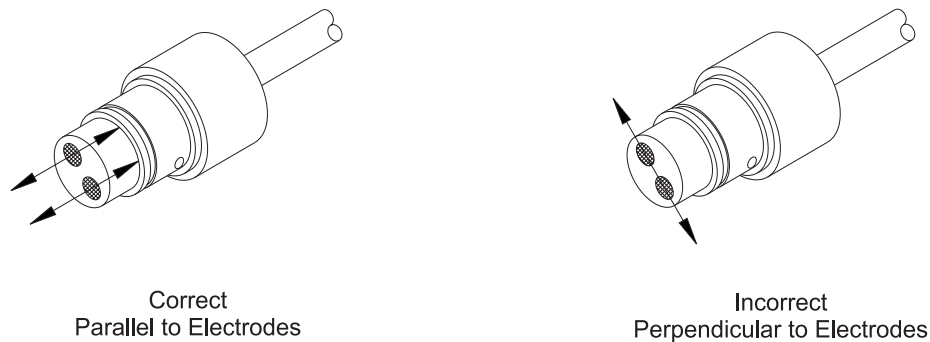

Figure 11

Frequency

The probe should periodically be cleaned to maintain accurate measurements. The frequency of cleaning required will vary from application to application. In a new installation, it is recommended that the probe be cleaned after two (2) weeks of service. In order to determine the frequency of cleaning, use the following procedure.

1. Read and record the conductivity with probe in system.
2. Remove the probe, clean it, and place it back into the system.
3. Read the conductivity of the probe after it is cleaned and record it.

Compare the first conductivity with the second. If the variance in readings is greater than 5%, increase the frequency of probe cleaning. If there is less than a 5% change in the reading, the probe was not dirty and can be cleaned less often.

7.0 Troubleshooting



Disconnect power to the controller before opening the front panel! Troubleshooting and repair of a malfunctioning controller should only be attempted by qualified personnel using caution to insure safety and to limit unnecessary further damage. Contact your local LMI distributor or the factory for assistance.

PROBLEM	POSSIBLE CAUSE	SOLUTION
No Power Light	Blown main fuse	Test with multimeter / replace if required
	No power supplied	Check power source
	Loose/incorrect wiring	Verify wiring connections
No Display	Blown main fuse	Test with multimeter / replace if required
	Blown secondary fuse	Test with multimeter / replace if required
	Faulty pcboard	Consult factory
No Pump Power	Alarm State/No Flow Exists	Check flow switch : 'Alarm Light On' below
	Incorrect wiring to pump	Check wiring by using Manual Relay Output Test program
	Pump has failed	Plug pump directly into live outlet
	Incorrect pump settings	Check programmed settings and modes
No Valve Power	Flow switch off	Check flow switch and wiring
	Incorrect wiring to valve	Check wiring by using Relay Test program
	Valve has failed	Test per manufacturers instructions
	Incorrect Blowdown setpoint	Verify setpoint and rising/falling trip selection
Low Conductivity	Bypass valve open	Verify valve alignment
	Airbound probe	Change probe location
	Solenoid valve stuck open	Repair or replace
	Sensor disconnected	Check and verify sensor
	Faulty cable or connector	Replace as required
High Conductivity	Probe is fouled or dirty	Clean as required - recalibrate
	Solenoid valve stuck shut	Repair or replace
	Bad bleed relay	Consult factory
Erratic Conductivity	Unit out of calibration	Recalibrate
	Unit will not calibrate	Out of range limits - Use Conductivity Test switch
	Stagnant sample	Check system for proper flow
	Conductivity is stuck on one value	Verify test switch is in Run mode not Test mode
	Faulty pc board	Consult factory
Alarm Light On	Alarm Condition Exists	Verify high conductivity set point
		Verify low conductivity set point
		Low chemical tank level (when wired)
No Flow Light On	No Flow circuit energized	Check wiring from flow switch to terminals
		Verify flow switch is moving freely
		Verify flow is present in manifold line

8.0 Factory Settings

Temperature	Fahrenheit	% Time -	10%
Conductivity Set point	2000 μ S	Feed after Bleed	10%
Delta Differential	100 μ S	Feed after Bleed - Limit	10 minutes
Low Alarm	100 μ S	Limit (Feed & Bleed).....	10 min limit
High Alarm	4000 μ S	Flow Alarm (On/Off).....	Off
Feed Mode	Pulse Timer	Trip (Rise/Fall).....	Rise
Pulse Timer	10 seconds	4 mAmp setting.....	0 μ S
Pulse Count	1 flow meter count	20 mAmp setting.....	20,000 μ S
% Time - Cycle Time.....	10 minutes	Display (μ S/PPM TDS).....	μ S
		Control (Boiler/Cooling Tower).....	Cooling Tower

9.0 Product Specifications

Power Requirements	115 VAC +/-15%, 50/60 Hz 230 VAC +/-15%, 50/60 Hz Voltage input selectable via a selector switch located on the I/O PCB Fuse: 4A 250 VAC Time Delay
Inputs	Flow Switch All low voltage inputs active low, i.e. the active state is when the switch is closed. The switch must be capable of switching 2 mA at +/-15 VDC.
Outputs	Alarm 4-20 mA: 600 ohms maximum
Keypad	Three key membrane keypad with tactile response Material: Polyester with a hard coat finish Actuation Force: 2.6N to 3.3N
Temperature Input	Thermistor resistance 10 k Ohms at 77° F [25° C] Temperature Display: 32° F to 212° F [0° C to 100° C] Temperature resolution: +/- 1.8° F [+/- 1° C]
Probe Input	Cell constant of 1.5 ESD Protection: 700 Volts Three (3) sample readings / second : display updated every second
Relays	Fuse protected electromechanical. Bleed/Control Relay (1): 250 VAC, 10 amp contact relay Feed Relay (1): 250 VAC, 10 amp contact relay Alarm Relay (1): 250 VAC, 10 amp contact relay Contact type: Normally open and normally closed contacts (FORM C) Change over relay
LCD Display	16-Digit Liquid Crystal Display [LCD] with green backlighting
Operating Temperature	32° F to 122° F [0° C to 50° C]
Memory Backup	EEPROM. Data retention of 10 years minimum
Environmental	Printed pc boards conformally coated. Enclosure: IEC IP65, NEMA 4X - Door closed. IEC IP NEMA - 12 Door open.
Mechanical	Two (2) pc boards Control CPU board: microcontroller and display - low voltage Terminal power I/O board: transformer, fuses, terminal blocks, relays

10.0 Product Exploded View

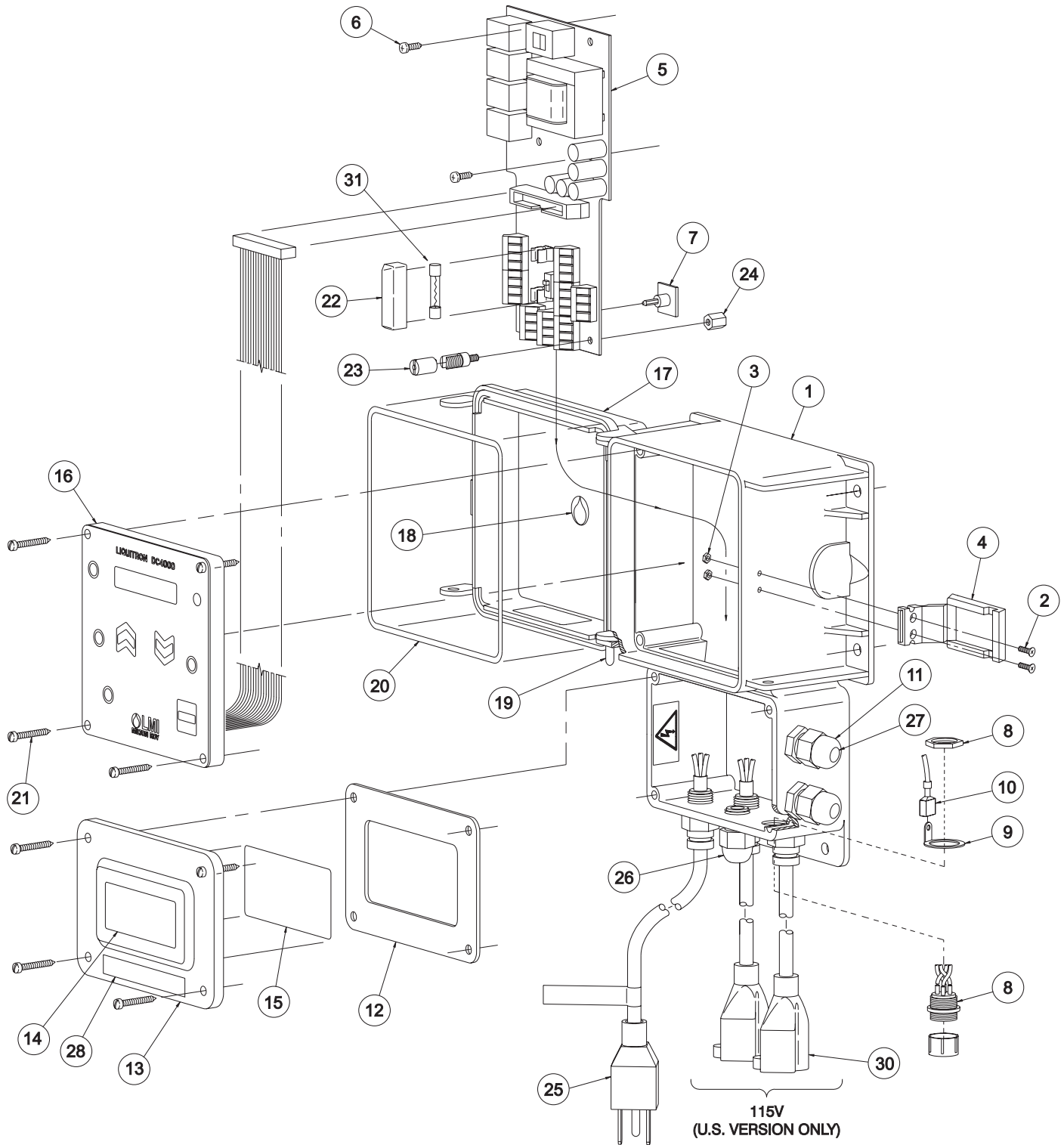

11.0 Parts List

Key No.	Part No.	Description
1	34675	Housing, Machined
2	32186	Screw, 4-40 x .37
3	32187	Nut, 4-40 Flush
4	32209	Latch, Machined
5	34710	I/O Board Assembly
6	31632	Screw, #6 x .38
7	34716	Standoff, Self Adhesive
8	25990	Connector Assembly
9	33566	Solder Lug Terminal
10	34735	Ground Wire Assembly
11	31571	Clamp, Cord (PG-9) (clamp for 4pin cable)
12	34074	Gasket, Foam
13	34088	Cover, Utility Box
14	30588	Label, LMI logo
15	34753	Label, DC4000
16	36525	Front Panel Assembly
17	31617	Cover, Liquitron™
18	32094	Label, Housing cover LMI
19	32211	Cap, .125 x .38
20	32352	O-Ring, Sponge
21	32395	Screw, Self-Tapping
22	34911	Cover, Fuse
23	32635	Terminal, Grounding
24	34915	Standoff, Hex, M4 x 10 mm
25	30749	Power Cord 115V - DC4000-1
	30751	Power Cord 220V US - DC4000-2
	30752	Power Cord DIN - DC4000-3
	34783	Cord Assembly UK - DC4000-5
	30754	Power Cord AUST - DC4000-6
	34784	Cord Assembly SWISS - DC4000-7
26	25957-1	Cord Clamp (Pg-9 clamp for female outlet power cord)
27	36810	Dowel
28	34931	Terminal Cover Label
30	35711	Cord, Power, 115V, NEMA 15-5 (female outlet power cord)
31	35712	Fuse, 4A Time Delay

12.0 Statement of Limited Warranty

LMI TERMS AND CONDITIONS OF SALE:

Visit the LMI web site at www.lmipumps.com for warranty details.



sales@novatech-usa.com

www.novatech-usa.com

Tel: (866) 433-6682

Fax: (866) 433-6684

Tel: (281) 359-8538

Fax: (281) 359-0084



LMI

201 Ivyland Road
Ivyland, PA 18974 USA
TOLL FREE: (800) 564-1097
TEL: (215) 293-0401
FAX: (215) 293-0445
<http://www.lmipumps.com>